

# Non-contact Gloss Meter

OPERATION MANUAL

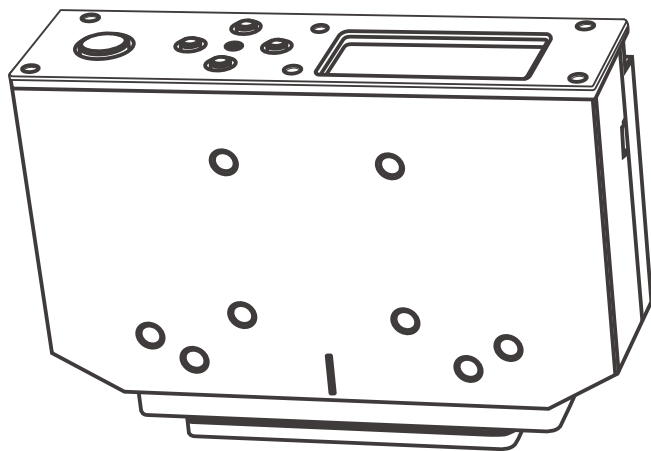

V1.0

Please read this manual carefully before using the instrument

# Content

Overview .....	1
1. External Structure Description .....	1
2. Measurement Principle and Introduction .....	2
3. Switch on/off .....	3
3.1 Startup .....	3
3.2 Shutdown .....	4
4. Basic Operation .....	4
4.1 Menu Operation .....	5
4.2 Enter the Main Menu .....	5
4.3 Confirm Prompt Interface .....	6
4.4 Input Prompt Interface .....	7
4.5 Editing Operation .....	8
4.6 Display Item .....	9
5. Instrument Calibration .....	9
5.1 Calibrate the Instrument .....	10
5.2 Modify Calibration Parameters .....	11
6. Measurement Modes .....	12
6.1 Switching Measurement Modes .....	12
6.2 Basic Mode .....	13
6.2.1 Measurement .....	13
6.2.2 Basic Mode Menu .....	14
6.3 Quality Control Mode .....	15
6.3.1 Interface Introduction .....	15
6.3.2 Measurement .....	16
6.3.3 Measure Standard .....	16
6.4 Statistical Mode .....	17
6.4.1 Interface Introduction .....	17
6.4.2 Measurement .....	18
6.4.3 Measure Standard .....	18

6.4.4 Set the Number of Measurements .....	19
6.4.5 Setting Display Options .....	19
6.5 Continuous Mode .....	20
6.5.1 Measurement .....	20
6.5.2 Specified Number of Measurements .....	22
6.5.3 Specified Measurement Time Interval .....	22
7. Data Management .....	22
7.1 Turn on/off the Storage .....	23
7.2 View Records .....	23
7.3 Delete Records .....	23
8. Standard Management .....	24
8.1 Turn on Difference Display .....	24
8.2 Browse/Edit/Delete Standards .....	24
8.3 Measure Standards .....	25
8.4 Create Standards .....	26
8.5 Clear Standards .....	26
9. Switching Angle .....	26
10. System Settings .....	26
10.1 Language Settings .....	27
10.2 Beep .....	27
10.3 Auto Shutdown Options .....	27
10.4 Reset the Instrument .....	27
10.5 View Device Information .....	28
11. Technical Specifications .....	28

## Overview

The non-contact glossmeter can measure without contacting the sample and will not pollute the sample. It is also easy to install and fast to measure. It is very suitable for automatic production line glossiness detection. It can find defective products in time and reduce production costs.

## 1.External Structure Description

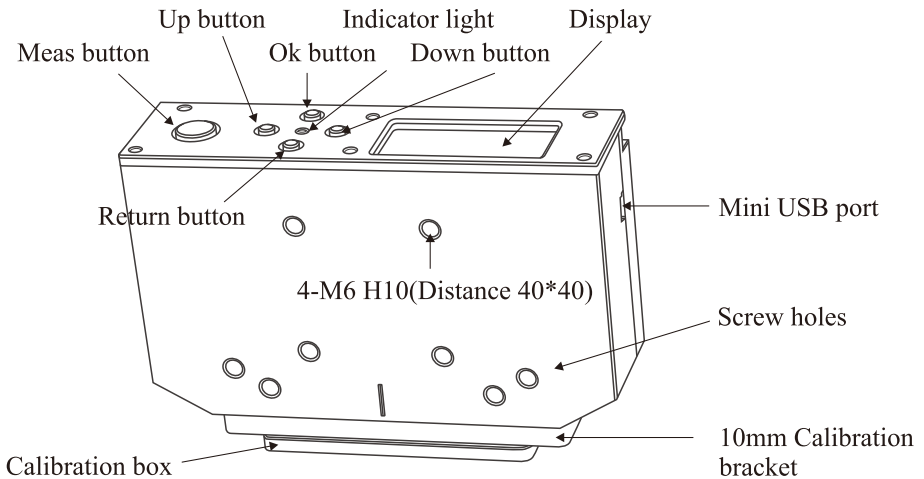

Figure 1 External structure

Button name	Icon	Function
Measurement button	◎	Switch ON/OFF, measurement, quick return to measurement interface, operation confirmation
OK button	✓	Display menu, prompt or operation confirmation
Return button	↶	Return to previous menu or cancel operation
Up button	↑	Move up menu items
Down button	↓	Move down menu items

*Remark: Use the above icons to represent the corresponding buttons in the instrument operation prompt*

## **2.Measurement Principle and Introduction**

This product conforms to the international standard ISO 2813 and the Chinese national standard GB/T9754, and meets the requirements of JJG696 working gloss meter. Under normal use conditions, Non-contact gloss meter is the same as our company's gloss meter. With automatic calibration, it has four measurement modes: basic mode, quality control mode, statistical mode and continuous mode to meet different measurement needs. At the same time, it has quality management software.

The special design of Non-contact gloss meter enables the instrument to carry out contact measurement and non-contact measurement with an interval of 10mm. As shown in the figure below, the distance between the calibration plate and the sample to be tested should be 10mm from the Non-contact gloss meter gloss base plate. When the instrument is connected to a 10mm calibration bracket (refer to Figure 1), the sample to be tested can be attached to the calibration bracket to achieve contact measurement. When the instrument is not connected to the 10mm calibration bracket (refer to Figure 1), the measured sample is 10mm away from the bottom of the instrument to achieve non-contact measurement.

There are two sampling procedures for Non-contact gloss meter. One is, in the normal measurement mode, that the lighting source is turned on, the sample to be tested is illuminated, the detector signal is collected, the lighting source is turned off, and the glossiness of the sample to be tested is output. The single measurement time is 1 second; the other is that when the online measurement mode is turned on, the lighting source will be turned on all the time, and the detector will collect and output signals uninterruptedly, so that the measurement period can be as short as possible, and the single measurement period is 180 milliseconds.

# Non-contact gloss meter

---

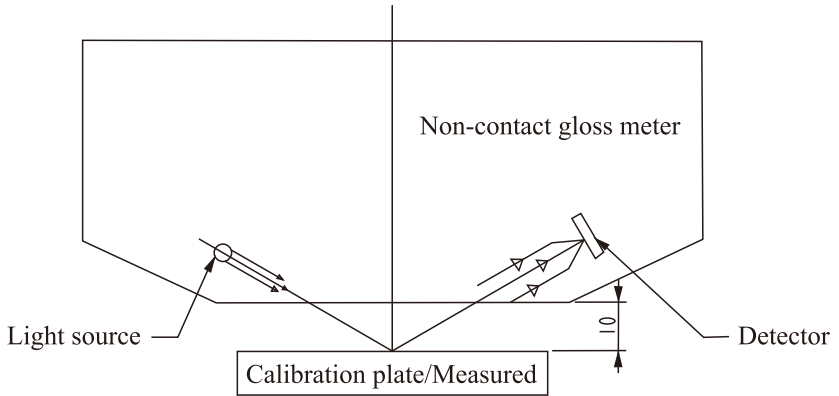

## 3. Switch on/off

### 3.1 Startup

The instrument is powered by an external power adapter through the USB interface (dry batteries can also be used in special cases). When using battery power, press the measurement button to turn on; if using USB power, it will automatically turn on when the USB is plugged in and connected to the power supply.

If the calibration plate is detected during startup, the instrument will be calibrated automatically.

If the calibration is passed, the interface shown in Figure 2 will be displayed, and at this time, press the measurement button to enter the measurement interface.

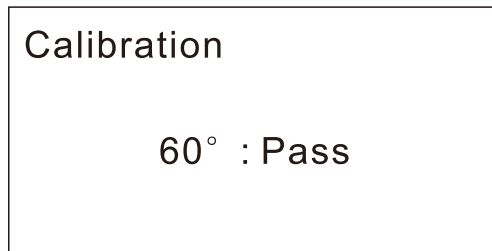

Figure 2 Calibration pass

If the calibration is failure, it is as shown in Figure 3.

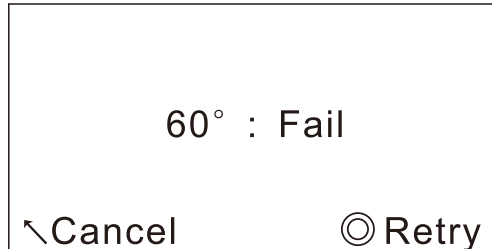

Figure 3 Calibration fail

After the calibration is failure, please choose to press the measurement button to retry or press the return button to directly enter the measurement interface. If you try again, please check these first:

1. Whether the calibration plate is in good connection or not;
2. Is the calibration tile clean?
3. Calibration tile protection paper is removed.

### **3.2 Shutdown**

When using battery power, the instrument will automatically shut down within a certain period of time (30 seconds by default, which can be changed in the settings).

It can also be turned off by pressing and holding the measurement button for more than 3 seconds.

It is not able to turn off when using USB power.

## **4. Basic Operation**

This chapter introduces some basic operations, which are the basis of the following chapters, and it is best to browse through them.

## 4.1 Menu Operation

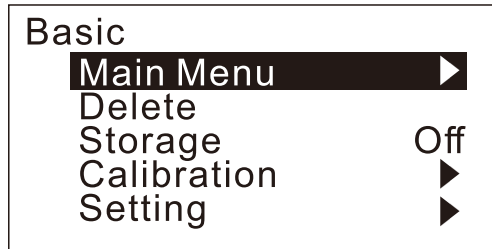

Figure 4 Menu introduction

Click the OK button on the measurement interface to enter the menu interface. In the menu interface, the item displayed in reverse color indicates the currently selected menu item.

Press the up and down buttons to change the currently selected item.

If there is a down arrow (↓) in the lower right corner, it means that there are more menu items that need to be turned up to see; if there is an up arrow (↑) in the upper right corner, it means that there are more menu items that need to be turned up to see.

If there is a triangle symbol (▷) on the right side of the menu item, it means that you can enter the submenu item by clicking the OK button.

---

*Tip 1: Normally press the measurement button on the menu interface to return to the measurement interface.*

---

## 4.2 Enter the Main Menu

Press the OK button in the measurement interface to enter the menu of the corresponding mode, and select "Main Menu", then press the OK button to enter the main menu.

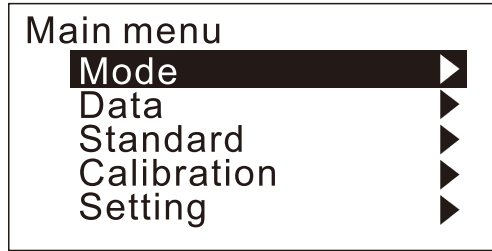

Figure 5 Main menu

The main menu contains the following items:

- Mode: Select the measurement mode;
- Angle: Select the measurement angle (only for multi-angles gloss meter);
- Data: Turn on/off storage function; check and delete records;
- Standard management: Turn on/off the difference value; check, modify, add and delete the standard;
- Calibration: Calibrate the instrument and modify the calibration parameters;
- Setting: System setting.

#### 4.3 Confirm Prompt Interface

The prompt interface is used to prompt to confirm an operation or not like deleting the record as shown in Figure 6.

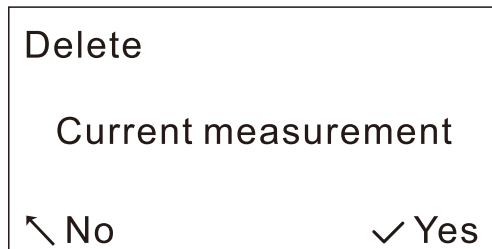

Figure 6 Delete the record

## Non-contact gloss meter

---

If you want to confirm the corresponding operation, press the OK button or the Measure button.

Press the return button if you want to cancel the operation.

---

*Tip 2: If confirming “No” in the prompt interface means pressing the return button to perform a “No” operation, and “Yes” means pressing the OK button to perform a “Yes” operation.*

---

### 4.4 Input Prompt Interface

The input interface is mainly used for prompting input the sample name or number as shown in Figure 7.

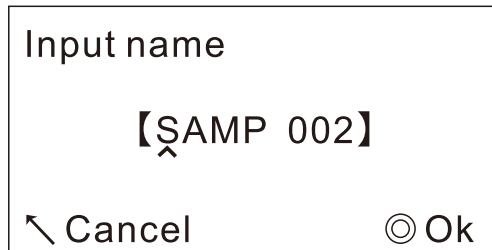

Figure 7 Input prompt interface

As shown in Figure 7, between the square brackets (between "[" and "]") is the input area, and the character on "^" is the current input focus.

Press the up or down button to switch the character at the focus position.

Press the OK button to move the input focus to the next position.

Press the measurement button to confirm the entry.

Press the return button to cancel the input operation.

---

#### 4.5 Editing Operation

The number or character displayed on the right side of some menu items is editable. For example, in the item of the average number of statistical modes, when press the OK button, it will display as shown in Figure 9, which is an edit area enclosed by square brackets. When display the editing area as shown in Figure 7, press the up and down buttons to switch the character at the focus, and press the OK button to move the edit focus to the next character, or press the return button to cancel the changes and press the measurement button to save the changes.

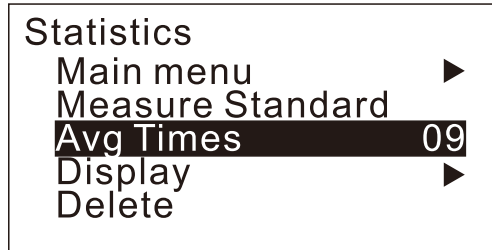

Figure 8 The number of average measurement is editable



Figure 9 Press OK button to edit the number of average times

#### 4.6 Display Item

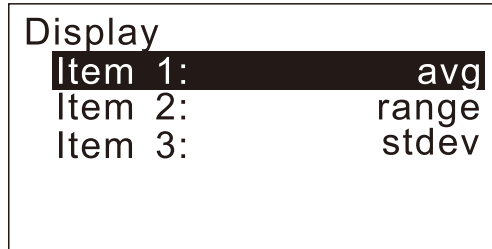

Figure 10 Display items in edit stats mode will show option box

Some setting values can only be one of several options. For example, in the display item of the statistics mode, press the OK button to select other options.

When you edit an item, it is anti-color display and the current item are enclosed in square brackets.

Press the up or down button to switch the current option.

Press the OK or measurement button to save the changes.

Press the return button to restore the original value.

### 5.Instrument Calibration

The calibration plate is automatically detected and calibrated when the instrument is turned on.

In order to the accuracy of measurement, it has to re-calibrate it after changing the power supply mode (for battery to USB or from USB to battery power), and it also needs to re-calibrate the instrument after modifying the calibration parameter. If the environment changes too much, it is also better to re-calibrate the instrument.

The related functions are under the Instrument Calibration menu.

Enter the main menu and select “Instrument Calibration” then press the OK button to enter the Instrument Calibration menu.

If you are in the basic measurement mode, you can also find the "calibration" menu item in the basic mode menu.

### 5.1 Calibrate the Instrument

Before calibration, please confirm that the calibration tile is clean and the calibration plate is in good connection.

During use, enter the “Calibration” menu to calibrate the instrument. Then select “Calibrate” in the “Calibration” menu as shown in Figure 11 and press the OK button.

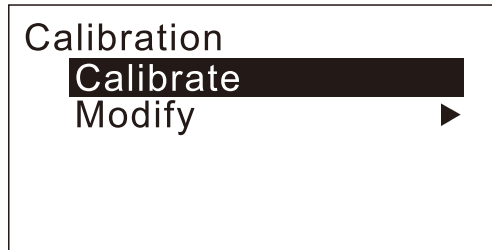

Figure 11 Press OK button after selecting "Calibrate"

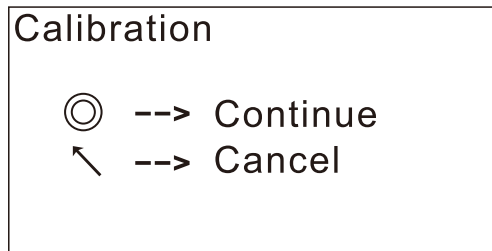

Figure 12 Press measurement button to start calibrate

This will enter the “Calibration” interface, and then press the measurement or OK button to start calibrate the instrument as shown in Figure 12.

When the instrument is calibrating, it will display “Calibrating” and flashes green light.

After the calibration is completed, if the calibration is successful, it is as shown in Figure 13. At this time, press the measurement button to return to the measurement interface or press the return button to return to the “Calibration” menu . If the calibration is failure, it is as shown in Figure 14. Press the measurement button or the OK button to retry, or press the return button to cancel it.

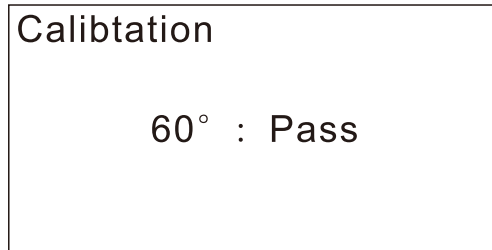

Figure 13 Calibration pass

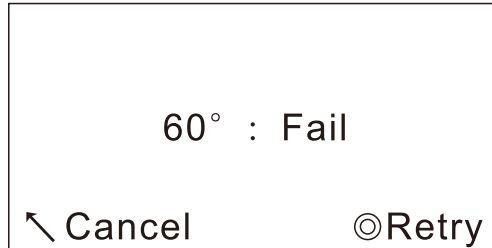

Figure 14 Calibration fail

### 5.2 Modify Calibration Parameters

Please modify the calibration plate parameters in the instrument simultaneously if replace or re-calibrate the calibration tile.

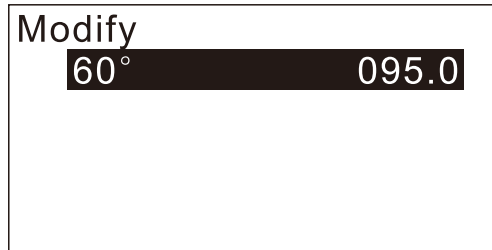

Figure 15 Modify the calibration board parameters

Please enter the “calibration” menu to modify the calibration tile parameters, then select the “modify parameters” menu item and press the OK button to enter the “modify parameters” interface.

Select the angle to be modified and press the OK button to start editing the corresponding value. Press the measurement button to save the changes after finishing the editing

**Note: The random change of the calibration tile parameters will lead to the inaccuracy of measurement. Please consult the factory to re-calibrate the calibration tile or replace the calibration plate.**

## 6.Measurement Modes

### 6. 1 Switching Measurement Modes

The instrument is in the basic mode when it is turned on for the first time. Please enter the “main menu” and select the “measurement mode” menu item, then press the OK button to the “Mode” interface to change the measurement mode as shown in Figure 16. Select the appropriate measurement mode and press the OK button.

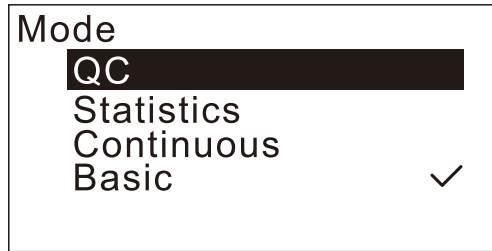

Figure 16 Measurement mode menu

## 6.2 Basic Mode

### 6.2.1 Measurement

Press the measurement button under the basic mode interface to measure. During the measurement, the green indicator lights up, while the green indicator goes out after the measurement is completed and display the measurement results as shown in Figure 17.

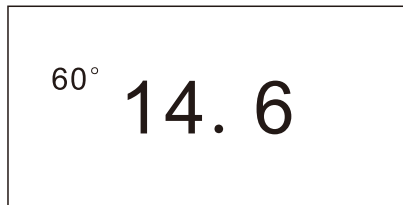

Figure 17 Basic mode measurement results

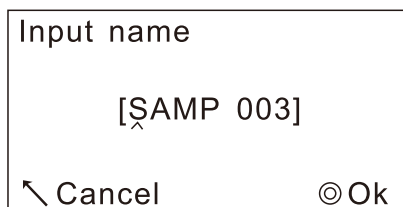

Figure18 Enter the sample name

---

## Non-contact gloss meter

---

If the storage function is turned on, it prompts to enter the sample name after each measurement is completed as shown in Figure 18. The system will provide a default name and press the measurement button to confirm the name and save it or press the return button to cancel it.

Press the return button to delete the measurement result as shown in Figure 19.

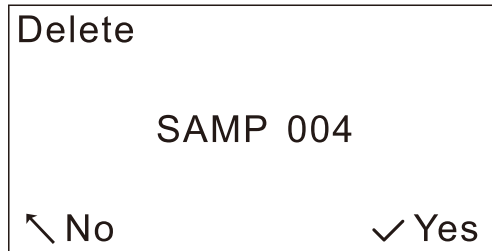

Figure 19 Press the return button to delete the measurement result

### 6.2.2 Basic Mode Menu

Press the OK button at the measurement interface to enter the basic mode menu.



Figure 20 Select "Main Menu" and press the OK button to enter the main menu

The basic mode menu contains the following menu items:

- The main menu: Enter the main menu;
- Delete: Delete the current measurement result;
- Storage: Enable or disable the storage function. If the storage function is turned on, “ON” will be displayed on the right, otherwise “OFF” will be displayed.
- Angle: Switch the instrument measurement angle (only for multi-angles instrument);
- Calibration: Functions related to instrument calibration, see 5 Instrument Calibration;
- Setting: Enter the system setting menu, see 10 System Setting.

## 6.3 Quality Control Mode

### 6.3.1 Interface Introduction

STD 01	SAMP 001		
	value	diff	pass
60°	14.7	0.0	OK

Figure 21 Figure 20 Select "Main Menu" and press the OK button to enter the main menu

The standard interface of the quality control mode is shown in the figure above, the upper left corner is the name of the current standard sample, and the upper right corner is the name of the current sample.

As shown in Figure 21, the "value" column shows the measured value; the "diff" column shows the difference between the sample value and the standard value; the "pass" column shows judgement results, and "OK" means within the tolerance of the standard, "NG" indicates out of tolerance.

If the difference display is not turned on, the measurement interface of the quality control mode is the same as the basic mode.

### 6.3.2 Measurement

Press the measurement button in the measurement interface to measure. The green light will light up during measurement, and will go out after the measurement is completed and the measurement result will be displayed.

### 6.3.3 Measure Standard

Press the OK button to enter the quality control mode menu, then select the measurement standard. After the measurement is ready, press the OK button to measure.

After the measurement is completed, the measurement result is displayed and prompted for confirmation as shown in Figure 22.

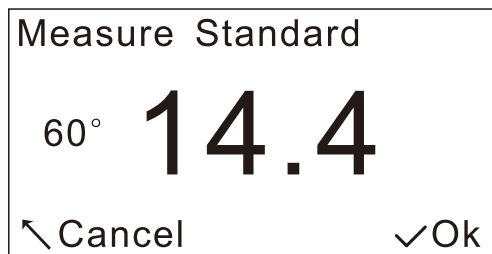

Figure 22 Confirm the measurement result of standard

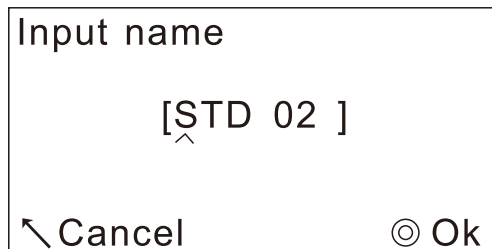

Figure 23 Enter the sample name

Press the OK button to confirm or press the return button to discard the result.

If the storage function is turned on, it prompts to enter the standard name after the confirmation is finished as shown in Figure 23.

After confirming the name of the standard, press the measurement button to save the standard or press the return button to cancel the storage. At this time the standard will be save as a temporary standard.

After the standard is measured, it is automatically set as the current standard; if the differential display is not turned on, it will be automatically turned on.

### 6.4 Statistical Mode

#### 6.4.1 Interface Introduction

As shown in Figure 24, in the top left corner of the statistics mode, it displays the current standard name. The first row in the upper right corner shows the current sample name, and the second row shows the number of measurements, which is displayed in the form of "m/n". "m" indicates the number of measured times and "n" indicates the total numbers of requirement measurement.

In the figure 24, "avg", "range", "stdev" each shows the average value, the variation range of m measurements, and the standard deviation. They can be changed in the Display Options in the Statistics Mode menu.

STD 03	SAMP 001		
			9/9
	avg	range	stdev
60°	14.6	0.4	0.0

Figure 24 Statistics Mode Measurement Interface

### 6.4.2 Measurement

After entering the statistical mode measurement interface, press the measurement button to measure. The measurement result will be updated at each measurement, and measurement will be automatically performed after the specified number of measurements. If the storage is turned on, it will prompt to enter the sample name when measurement is finished.

Please press the down button to finish the current measurement if the setting numbers of measurements are not enough.

Please press the up button (this operation can only be performed when the measurement is not completed) to delete the previous measurement data.

Please press the return button to delete the measurement result.

### 6.4.3 Measure Standard

Press the OK button to enter the statistical mode menu, then select the “Measure Standard” menu item, and press the OK button to enter the standard measurement interface.

The "m/n" in the top left corner of the measurement interface shows the current number of measurements and the total number of required measurements.

The "avg" column in the measurement interface shows the average of m measurements; the "min" column shows the minimum value in m measurements, and "max" shows the maximum value in m measurements.

Measure	Standard		
	avg	min	max
60°	14.7	14.7	14.7

2/4

Figure 25 Statistics mode measurement standard interface

After entering the standard measurement interface, press the measurement button to measure. After measuring for a specified number of times, if the storage is turned on, it will be prompt to input the standard name, otherwise it is set as a temporary standard.

During the measurement, press the return button to cancel the measurement or press the OK button to complete the measurement.

### 6.4.4 Set the Number of Measurements

Enter the statistics mode menu and select the "Average" menu item, then press the OK button to modify the number of measurements.

The number of measurements in the statistical mode can be set from 2 to 99 .

### 6.4.5 Setting Display Options

After entering the statistics mode menu, select the "Display Options" menu item, and then press the OK button to enter the display options setting page.

The statistical mode measurement interface can display up to three columns, corresponding to the first, second and third items respectively.

The available display items are:

- "avg": Average;
- "min" : The minimum value of the measured value;
- "max" : The maximum value of the measured value;
- "range" : The value that the maximum value minus the minimum value;
- "stdev" : Standard deviation;
- "diff" : Difference that minus the standard deviation;
- "pass": The result of comparison with the standard sample, "OK" or "NG";
- Blank: no display.

The standard deviation calculation formula is:

$$\text{stdev} = \sqrt{\frac{\sum_{i=1}^n (x_i - \bar{x})^2}{n - 1}}$$

## 6.5 Continuous Mode

### 6.5.1 Measurement

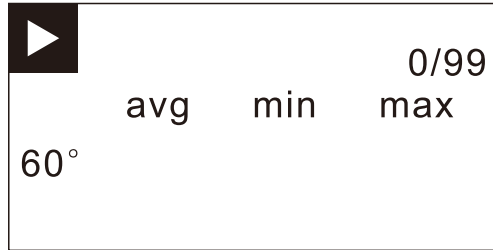

Figure 26 Continuous measurement interface (Ready)

Press the measurement button in the continuous measurement interface to start measurement.

If the storage is enabled, it will prompt to enter a name before the measurement. This name will be used as the first measurement name as shown in Figure 27, and subsequent measurements will be automatically incremented based on the name.

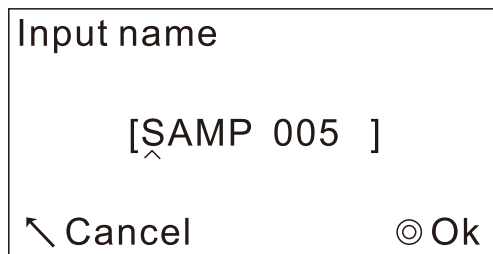

Figure 27 Enter the name of the first measurement

As shown in Figure 28, it will display each measurement result and the times that are measuring.

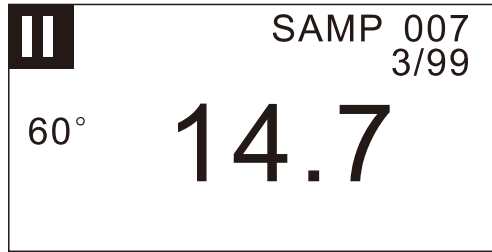

Figure 28 Continuous measurement interface (Measuring)

Press the measurement button or the return button during measurement to pause the measurement. When the measurement is paused, the average value ("avg" column), minimum value ("min" column), and maximum value ("max" column) of all measured samples are displayed as shown in Figure 29. Press the measurement button again to continue measurement.

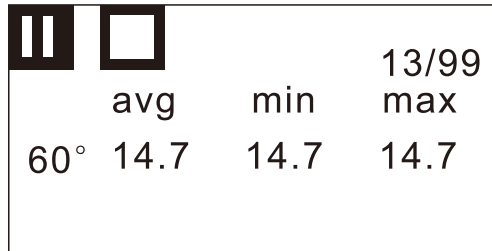

Figure 29 Continuous measurement interface (Pause)

Press the OK button while paused to abort the measurement and press the OK button again to display the continuous mode menu.

When the measurement is performed a specified number of times, the measurement is stopped and the average, minimum, and maximum values of all measured samples are displayed.

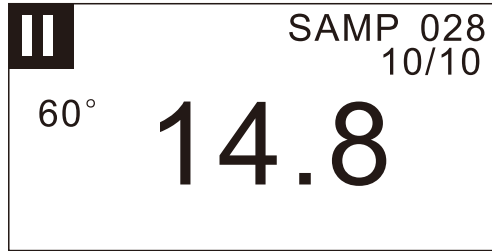

Figure 30 Continuous measurement interface (Complete)

### 6.5.2 Specified Number of Measurements

In the measurement interface, press the OK button to enter the continuous mode menu (If measurement is in progress, it needs to stop the measurement first), and select the "measurement times" menu item then press the OK button to modify. The number of measurements can be specified from 1 to 999 .

### 6.5.3 Specified Measurement Time Interval

In the measurement interface, press the OK button to enter the continuous mode menu (If measurement is in progress, it needs to stop the measurement first), and select the "Measurement interval" menu item then press the OK button to modify. The measurement time interval can be specified from 2 to 120 seconds. The measurement time interval refers to the interval of two measurements.

## 7.Data Management

Enter the main menu to select the "Storage" menu item and press the OK button to enter the data management interface.

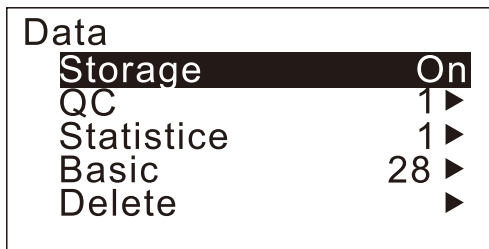

Figure 31 Storage menu

---

### **7.1 Turn on/off the Storage**

Select the "Storage" menu item and press the OK button. After modifying the switch options, press the measurement button to save the changes.

### **7.2 View Records**

Record types are divided into quality control records, statistical records, and basic records. The quality control records store the quality control measurement results; the statistical records store the statistical measurement results; the basic records store the basic model and continuous model measurement results.

To view the corresponding record, select the appropriate record and press the OK button to start browsing.

Press the up or down button during browsing to switch the records.

Press the return button to return to the storage menu.

Press the measurement button to return to the measurement interface.

### **7.3 Delete Records**

Select the "Delete" item of the storage and press the OK button to enter the "Delete" menu. Then select the record type to delete, press the OK button after selecting, and it will prompt to confirm the operation by pressing the OK button or the measurement button or cancel it by pressing the return button.

**Note: The delete operation will empty all corresponding records at once, so please operate with caution.**

## 8. Standard Management

In the main menu, select "Standard Management" and press the OK button to enter the standard management menu.

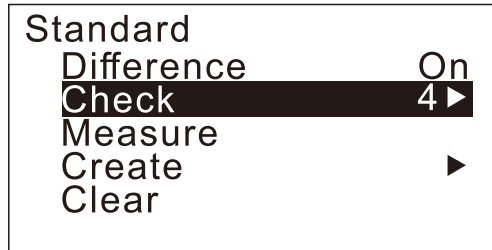

Figure 32 Standard management menu

### 8.1 Turn on Difference Display

In the standard management menu, select "Difference Display" and press the OK button to modify the difference display switch. After the modification, press the measurement button or OK button to save the changes.

### 8.2 Browse/Edit/Delete Standards

In the standard management menu, select "Browse Standards" and press the OK button to enter the browse standards interface as shown in Figure 33.

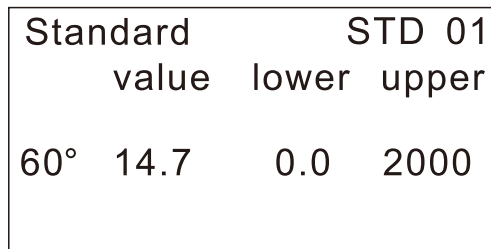

Standard			STD 01
	value	lower	upper
60°	14.7	0.0	2000

Figure 33 View standards interface

In the figure 33, the upper right corner shows the standard name. If it is the current standard, "\*" will be displayed in front of the name.

"value" is the target value of the standard, "lower" is the lower limit of the qualified sample, and "upper" is the upper limit. In the quality control or statistical mode, within the range of upper and lower limits are "OK", exceeding it is "NG".

Press the up or down button while browsing the standard to switch the standard.



Figure 34 View standards menu

Press the OK button to open the browse standards menu, as shown in Figure 34.

The View standards menu includes:

- Set as the current standard: set the browse standard as the current standard;
- Modify the standard: modify the name and value of the viewing standard;
- Delete: delete the viewing standard.

### 8.3 Measure Standards

In the standard management menu, select "Measure" and press the OK button to perform the measurement.

Use average measurements in statistical mode, otherwise use basic measurements.

The average measurements procedure is similar to the standard measurement under the statistical mode standard menu. The basic measurement is similar to the standard measurement in the quality control mode.

### 8.4 Create Standards

Select "Create" in the standard management menu and press the OK button to create a new standard, as shown in Figure 35. Then, in the "Create Standards" interface, modify the name of the Standard and set the target value and upper and lower limits for each angle.

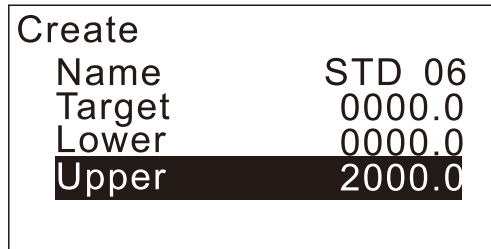

Create	
Name	STD 06
Target	0000.0
Lower	0000.0
Upper	2000.0

Figure 35 Create standards interface

### 8.5 Clear Standards

Clear Standards will delete all stored standards.

In the standard management menu, select "Clear" and then press the OK button.

The system will prompt to confirm. Press the measurement button or OK button to execute the emptying operation or cancel it by pressing the return button.

## 9.Switching Angle

For multi-angles instruments, it is able to modify the measurement angle.

In the main menu, select "Geometry" and press the OK button. Then select the angle to use when measuring and press the OK button.

## 10.System Settings

In the main menu, select the "Setting" menu item and press the OK button to enter the System Settings menu.

### **10.1 Language Settings**

After selecting "Language Settings" in the system settings menu, press the OK button to enter the language menu. Select the required language and press the OK button to set it as the system language.

### **10.2 Beep**

In the system settings menu, select the "Beep" menu item and press the OK button, then modify the switch options. After the modification is completed, press the OK button or the measurement button to save the changes.

### **10.3 Auto Shutdown Options**

In the Setup menu, select the "Auto Shutdown" menu item and press the OK button, then modify the idle waiting time for automatic shutdown.

The automatic shutdown time can be set to 30 seconds, 60 seconds, 90 seconds, 2 minutes, or never shut down.

Automatic shutdown is only valid when using battery power, and it can not be turned off when using USB power.

### **10.4 Reset the Instrument**

Reset the instrument when the system is abnormal.

Resetting the instrument will erase all user data and settings except calibration tile parameters, so please use it with caution.

Press the OK button after selecting "Reset Instrument" in the system menu. At this time, the system will prompt to execute the operation or not. If confirm to execute the operation, please press the OK button or measurement button, or cancel the operation by pressing the return button.

### 10.5 View Device Information

In the system menu, select "Device Information" and press the OK button to view the device information.

The device information includes the instrument model ("Model"), serial number ("SN"), software version number ("S.V."), and hardware version number ("H.V").

## 11. Technical Specifications

<b>Product Model</b>	Non-Contact Gloss Meter
<b>Measuring Angle</b>	60°, Conform to Standards: ISO 2813, ASTM D 523, GB/T 9754
<b>Measuring Spot(mm)</b>	60°:9X15
<b>Measurement Range</b>	60°:0~1000GU
<b>Division Value</b>	0.1GU
<b>Non-contact Distance</b>	Non-contact distance 10.0mm±0.1, the parallelism between the measured surface of the sample and the measuring aperture surface is 0.2 degrees
<b>Features</b>	It can be used for gloss measurement and quality inspection in paint ink, coating, paper printing, plastic electronics, furniture, ceramics, electroplating, hardware, marble and other industries. The non-contact test between the test probe and the tested sample realizes the non-contact test of samples such as liquids, pastes, powders, and fragile objects. The measurement time can be as fast as 0.2 seconds, and it can communicate with other systems through Bluetooth or USB, and demonstrate routines of various communication interfaces. Software functions can be customized (according to the evaluation of the situation, additional customization fees will be generated).
<b>Measuring Modes</b>	Basic Mode, Statistical Mode, Continuous Mode, Quality Mode
<b>Measuring Time</b>	0.2s/1s
<b>Repeatability</b>	0~100GU: ±0.5GU ; 100~1000GU: ±0.5%GU Test at intervals of 5 seconds under 10mm verification tooling (ensure test distance 10 and parallelism)
<b>Accuracy</b>	Meet the requirements of JJG 696 working gloss meter
<b>Auto shutdown time</b>	30s、60s、90s、2min or Never Shut Down
<b>Long-time Calibration</b>	With automatic calibration standard function and manual calibration
<b>Language</b>	Simplified Chinese, English, Traditional Chinese
<b>Storage</b>	35000pcs(15,000 records in basic mode and continuous mode, 10,000 records in quality control mode, and 10,000 records in statistical mode)

## Non-contact gloss meter

---

<b>Display</b>	2.3 inch black and white display
<b>Dimension</b>	140X83X38mm(Not including calibration bracket and calibration plate)
<b>Weight</b>	About 500g
<b>Power Supply</b>	Use the USB interface power adapter
<b>Data Port</b>	USB, Bluetooth
<b>PC Software</b>	Quality management software, quality inspection report printing, more function expansion
<b>Operation Temperature Range</b>	0~40°C(32~104°F)
<b>Storage Temperature Range</b>	-20~50°C(-4~122°F)
<b>Humidity</b>	Less than 85%RH, no condensation
<b>Standard Accessories</b>	Power adapter, quality management software (official website download or after-sales), calibration plate, calibration bracket



2.004.01.0122