

NEW

**Benchtop
spectrophotometer**
OPERATION MANUAL

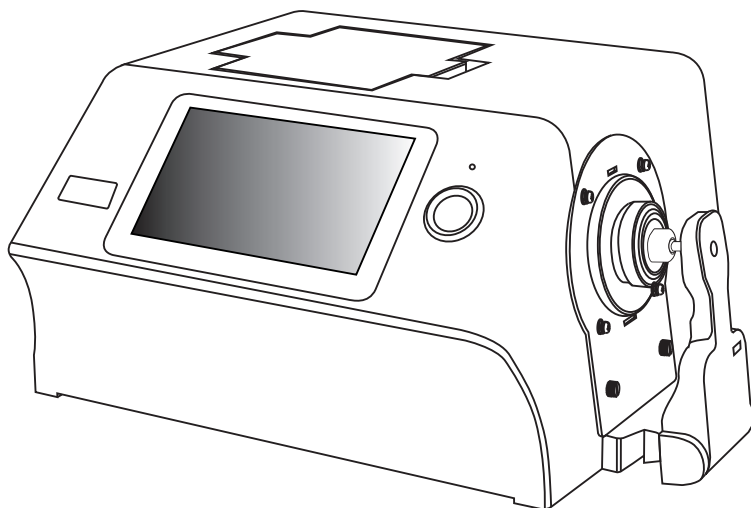

V2.0

Please read this manual carefully before use .

Safety Instructions

Safety Symbol

In order to avoid accidents caused by improper operation, the following symbols are used in this manual or on the instrument label.



This symbol instructs relative safety warnings or precautions.
Read these instructions carefully to use this instrument safely and correctly.



This symbol is a description of electrical hazards associated with electric shock.
Read these instructions carefully to use this instrument safely and correctly.



This symbol is a description of fire hazards.
Read these instructions carefully to use this instrument safely and correctly.



Represents a prohibiting execution. This is absolutely not executable.



Represents an instruction.
The instruction must be strictly performed.



Represents a prohibiting execution.
Do not disassemble this instrument.



Represents an instruction.
Make sure that the AC adapter is pulled out from the AC socket.

Safety Instructions

Cautions

- No copy or copy of all or part of this manual is strictly prohibited without authorization from the company.
- The contents of this manual are subject to change without prior notice.
- When preparing this manual, we have done our best to ensure the accuracy of its contents. If you have any questions or find any errors, please contact your retailer or our authorized maintenance agency.
- The company has no liability for all consequences arising from the improper operation of this instrument.



Safety Instructions

Safety Measures



To ensure proper use of this instrument, please read carefully and strictly observe the following points.



Warning: Failure to comply with the following points may pose a danger to personal safety.

| | |
|---|--|
|  | <ol style="list-style-type: none">1. Do not use this instrument in a place where there are combustible or flammable gases (gasoline, etc.), otherwise it may cause fire.2. Do not allow liquid or metal objects to enter the instrument, otherwise it may cause fire or electric shock. If a liquid or metal object enters the instrument, turn off the power immediately, unplug the AC adapter plug, and contact the nearest authorized maintenance institution.3. Do not force, twist or pull the power cord of the AC adapter. Do not scrape or modify the power cord, or place heavy objects on the power cord, otherwise it may damage the power cord, and cause fire or electric shock.4. Do not use wet hand to plug AC adapter plug, otherwise it may cause electric shock.5. If the instrument or AC adapter is damaged, or smokes, do not continue to use this instrument, otherwise it may cause fire. In this case, power should be switched off immediately, AC adapter plug removed from the AC socket, and contact the nearest authorized maintenance institution.6. Do not measure the face directly on the sample measuring aperture, otherwise it may damage the eyes. Do not place the instrument on an unstable or inclined surface, or it may cause the instrument to slide or overturn, causing injury to personnel. |
|  | <ol style="list-style-type: none">1. Be sure to always use a standard AC adapter or an optional AC adapter and connect it to an AC socket with rated voltage and frequency. If you use a not specified AC adapter, it may damage the instrument or cause a fire or electric shock. |

Safety Instructions

| | |
|---|--|
|  | 2. Be careful not to put your hand in the notch of the instrument, or you may get stuck in your finger and cause injury. |
|  | Do not disassemble or refit the instrument or AC adapter, otherwise it will cause fire or electric shock. |
|  | <ol style="list-style-type: none">1. If the instrument is not used for a long time, please pull the AC adapter plug from the AC socket. Because the dust or water stains on the AC adaptor pins may cause a fire, they should be pulled out immediately.2. When pulling the AC adapter plug out of the AC socket, be sure to always hold the plug itself to avoid pulling the power cord, which may damage the power cord and cause fire or electric shock. |

The benchtop spectrophotometer is designed for the measurement of color and color difference in all fields. It can measure the color for reflection and transmission with high accuracy.

Operating Environment

- Please use this instrument at ambient temperatures ranging from 0°C to 40°C without condensation. Do not use this instrument in areas where temperature varies dramatically.
- Do not place this instrument near direct sunlight or heat sources such as furnaces. In this case, the internal temperature of the instrument may be higher than the ambient temperature.
- Do not use this instrument in the presence of dust, cigarettes or chemical gases, or it may cause performance degradation or even system collapse.
- Do not use this instrument near devices such as loudspeakers that generate strong magnetic fields.
- The bench-top spectrophotometer and its standard AC adapter are designed for indoor use only. Because rain or other factors may damage the instrument, so do not use it outside.

Technical Description

White Calibration Plate

- Do not scrape or dirty the white correction board, for example, do not leave fingerprints.
- When white calibration plate is not used, be sure to place them properly to prevent white calibration plate from being exposed to light.
- To achieve accurate measurement, we advise that the white calibration plate should also be calibrated periodically.

Power

- Ensure that the power switch is switched to "O" when the benchtop spectrophotometer is not used.
- Make sure you always use a standard AC adapter and connect it to an AC socket with rated voltage and frequency.

CATALOGUE

| | |
|--|-----|
| Safety Symbol..... | II |
| Safety Measures..... | III |
| Operating Environment..... | IV |
| Instruction..... | 1 |
| Cautions..... | 1 |
| 1. External Structure And Description..... | 3 |
| 2. Operating Instruction..... | 6 |
| 2.1 Power On & Off..... | 6 |
| 2.2 Calibration..... | 6 |
| 2.2.1 Reflection Measurement Mode Calibration..... | 6 |
| 2.2.2 Transmission Measurement Mode Calibration..... | 9 |
| 2.2.3 Haze Measurement Mode Calibration..... | 11 |
| 2.3 Measurement..... | 12 |
| 2.3.1 Measurement Instruction..... | 12 |
| 2.4 Measurement Settings..... | 17 |
| 2.4.1 Average Measurement..... | 17 |
| 2.4.2 Continuous Measurement..... | 18 |
| 2.5 Measurement..... | 19 |
| 2.5.1 Reflection Standard /Sample Measurement..... | 19 |
| 2.5.2 Transmission Standard/Sample Measurement..... | 20 |
| 2.5.3 Haze Standard / Sample Measurement..... | 21 |
| 2.5.4 Opacity Target /Sample Mesurement..... | 23 |
| 2.6 Connection To Pc..... | 25 |
| 2.6.1 Usb Connection..... | 25 |
| 2.6.2 Bluetooth Connection..... | 25 |
| 2.7 Tolerance Setting..... | 26 |
| 2.7.1 System Tolerance Setting..... | 26 |
| 2.7.2 Standard Tolerance Setting..... | 27 |
| 2.8 Print..... | 28 |
| 3. System Functions..... | 29 |
| 3.1 Data Management..... | 29 |
| 3.1.1 Check Record..... | 30 |
| 3.1.2 Delete Record..... | 33 |
| 3.1.3 Search Record..... | 33 |
| 3.1.4 Standard Input..... | 35 |
| 3.2 White And Black Calibration..... | 36 |
| 3.3 Light Source..... | 36 |
| 3.4 Measurement Mode..... | 37 |

CATALOGUE

| | |
|--|----|
| 3.5 Color Options..... | 39 |
| 3.5.1 Color Space..... | 39 |
| 3.5.2 Color Formula..... | 40 |
| 3.5.3 Color Index..... | 40 |
| 3.6 Parametric Settings..... | 41 |
| 3.7 Display Setting..... | 43 |
| 3.8 System Setting..... | 44 |
| 3.8.1 Auto Save..... | 45 |
| 3.8.2 Bluetooth..... | 46 |
| 3.8.3 Buzzer Switch..... | 46 |
| 3.8.4 Automatic Switching To Sample Measurement..... | 46 |
| 3.8.5 Print Data..... | 46 |
| 3.8.6 Control Mode..... | 46 |
| 3.8.7 Language Setting..... | 47 |
| 3.8.8 Time Date Setting..... | 47 |
| 3.8.9 Backlight Time..... | 48 |
| 3.8.10 System Tolerance..... | 49 |
| 3.8.11 Temperature Threshold..... | 49 |
| 3.8.12 Calibration Valid..... | 49 |
| 3.8.13 System Error..... | 50 |
| 3.8.14 Restore Factory Settings..... | 51 |
| 3.8.15 About Instrument..... | 51 |
| 4. Daily Maintenance..... | 52 |
| 5. Technical Parameters..... | 53 |
| 5.1 Product Feature..... | 53 |
| 5.2 Technical Specifications..... | 54 |

Instruction

Benchtop grating spectrophotometer is an excellent color measurement instrument with excellent stability. The instrument hold as large as 7 inch capacitive touch screen. According to the geometric optical illumination $D/8^\circ$ (Reflection) and $D/0^\circ$ (Transmission), the instrument can measure Reflection/Transmission and colorimetric data of various samples. In order to meet different measurement requirements, the instrument is equipped with kinds of reflective measuring apertures such as $\Phi 25.4\text{mm}$, $\Phi 15\text{mm}$ (for partial model), $\Phi 8\text{mm}$, $\Phi 4\text{mm}$. The wavelength range is from 360~780nm, 400nm/420nm cut-off light source, 460nm cut-off light source (for partial model). By switching on-off, the instrument can measure colorimetric data for all kinds of sample/UV sample.

With USB, Bluetooth dual mode and with high-end color management software which can be connected to PC to achieve more extension functions, it has the character of stable working, accurate color measurement, large storage capacity and it is good to achieve the accurate color analysis and transmission. The instruments also can be accurate in measuring equipment for color matching system and widely used in color quality control area. They are widely used in plastic, electronics, paints, textile, printing, automobile, medical, cosmetic and food industries or science research institutes and laboratories

Cautions

- The spectrophotometer is a precise measuring instrument. Please avoid drastic changes of external environment when measuring. These changes, including the flash of surrounding light and the rapid change of temperature, will affect measurement accuracy.
- Keep the instrument balanceable,--stable, make sure the measuring aperture touch the surface of the test sample placidly, and no shaking or shifting when measuring. Please prevent the colorimeter from fierce collision or crash.
- The instrument is not waterproof. Do not use it in high humidity environment or in water.
- Keep the instrument clean. Avoid dust, powder or solid particles entering the measuring aperture and the instrument.
- Replace the white calibration cavity and put the spectrophotometer into

Benchtop Spectrophotometer

instrument case when not in use.

- Please power it off to prevent the instrument from damage if you don't use it for a long time.
- Please keep the instrument in a cool dry place.
- Any unauthorized changes to the instrument are not permitted, or it will affect the measuring accuracy, even cause irreversible damage.

1.External structure and description

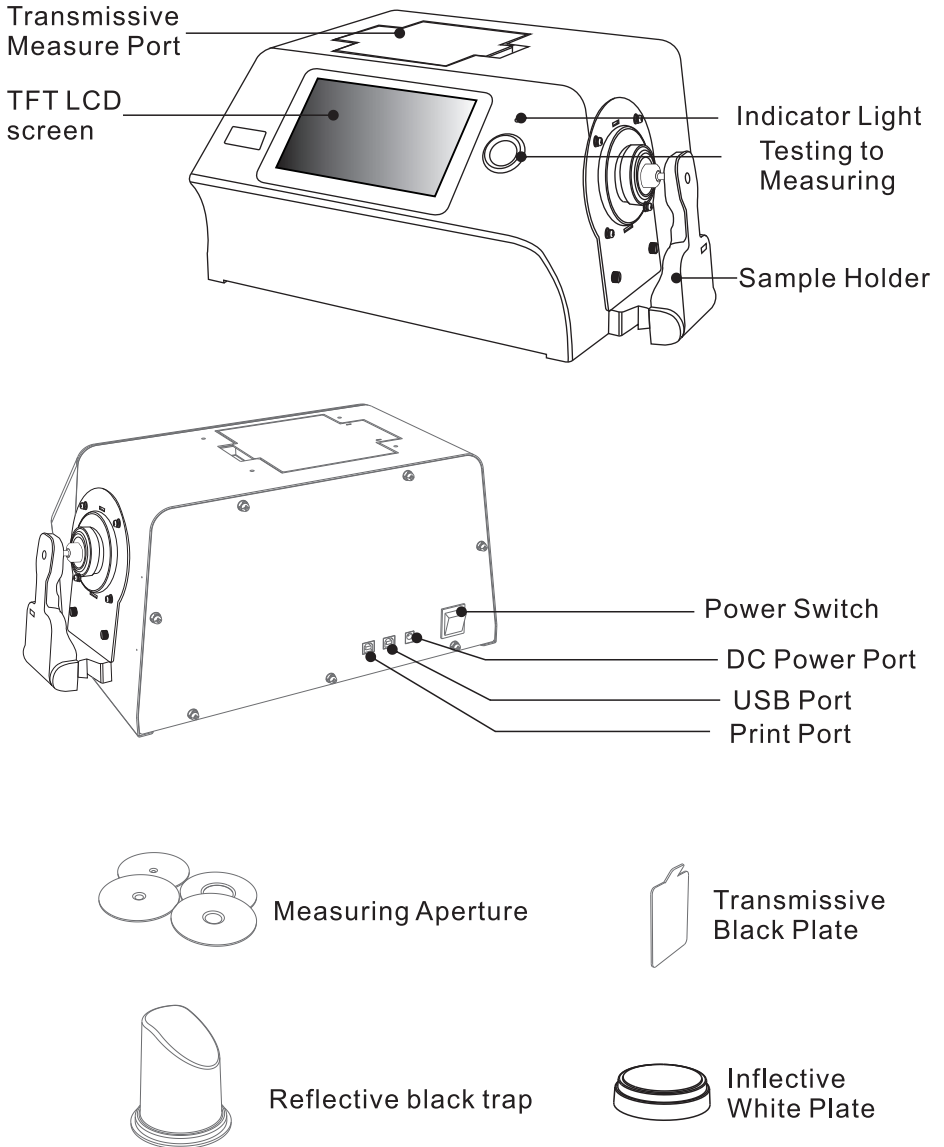

Figure 1 Instrument Structure Diagram

Benchtop Spectrophotometer

Display: 7-inch TFT color LCD, Capacitive Touch Screen,
Used to display measurement data and instrument operation navigation.

Indicator Light:

- * The instrument is energized (the power adapter is energized when the switch is turned to "I"), The indicator light is on.
- * LED light includes green and red.
- * Green LED light flashes during measuring and keep green after measuring. If during measurement the instrument runs abnormal, it turns to red and keep red.

Wake-up/Measuring button :

- * Pressing the button shortly is to wake up the system and start measuring.
- * Pressing the button during measurement will cause operation invalid.

Reflective Measuring Port:

During Reflective measuring mode, the sample should cling to the measuring aperture tightly fixed by sample holder.

Meanwhile, the transmission measurement aperture remains unshielded and the cover above the port should be closed.

Transmissive Measuring Aperture:

During Transmissive measuring mode, the sample should cling to the measuring aperture tightly fixed by clamp component. The cover above the port should be closed, meanwhile the Reflective white calibration plate should be placed to the reflective measuring port.

Sample Fixing Clamp:

It's for clamping sample during Reflective measuring mode.
When the sample is heavier, it can be supported by a bracket.

Measuring Aperture:

* Reflective measuring apertures: $\Phi 25.4\text{mm}$ / $\Phi 15\text{mm}$ (some models without this model)/ $\Phi 8\text{mm}$ / $\Phi 4\text{mm}$;

* Transmissive measuring apertures: $\Phi 30\text{mm}$ / $\Phi 25\text{mm}$;

*The customer selects the appropriate measuring aperture according to the tested sample dimension. the bigger apertures have more accurate measurements.

*During transmissive measuring mode, only switch $\Phi 25.4\text{mm}$ and place reflective white plate to the reflective measuring aperture.

Reflective Black Calibration Cavity:

During Reflective measuring mode, black calibration is used as the 0 benchmark. For specific operation please refer to the section of black and white calibration.

Reflective White Calibration Plate:

During Reflective measurement mode, white calibration is used as the highest reflectance test benchmark of the instrument. for specific operation please refer to the section of black and white calibration.

Transmissive Black Calibration Plate:

During Transmissive mode, black calibration is used as the 0 benchmark. For specific operation please refer to the section of black and white calibration.

Print Port:

It is to connect printer, used to print colorimetric data.

USB Port:

USB port is used to connect with PC computerized high-end color management software to achieve more extension functions.

DC Power Port:

The power adapter connects Alternating Current (AC110V-240V) to power the instrument. The specification of external power adapter is DC 24V/3A.

Power Switch:

Setting power switch to "I", it turns the power ON, and setting to "O", it turns the power OFF. We set power ON or OFF by toggling the switch.

2. Operating Instruction

2.1 Power On & Off

Press the power switch to "I", to power up the instrument.

When the indicator light turns green, the instrument is on in normal. Press the power switch to "O", the instrument is turned off, and the indicator light goes out.

If the operation is not done for a long time when the instrument is on, it will automatically enter into standby mode. At this time, press the test key to wake-up the instrument to keep working. Please refer to the instruction section of screen backlight.

Please cuff off the power if not to use the instrument for a long time.

2.2 Calibration



Black and white calibration is required under the following circumstances.

- 1、 Before the first time of measuring after power is on.
- 2、 Before the first time of measuring after switching measuring aperture.
- 3、 Before the first time of measuring after switching reflective and transmissive mode.
- 4、 Before the first time of measuring after switching UV mode.
- 5、 When the environmental condition change relatively large (such as temperature changes exceeding 5 degrees Celsius).
- 6、 Use the instrument for a continuous long time (over 8 hours).
- 7、 When the user finds that the measuring data is inaccurate.

2.2.1 Reflection Measurement Mode Calibration

First of all, ensure that the instrument is in Reflective Measurement Mode (for specific settings please refer to section 3.4).

Calibration Steps:

- 1、 Standard measurement interface in Figure 2, click  or in other interfaces click  to enter the main menu, as shown in the following figure.

Benchtop Spectrophotometer

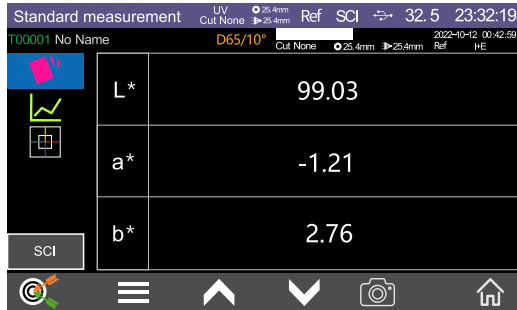

Figure 2 Standard Measurement

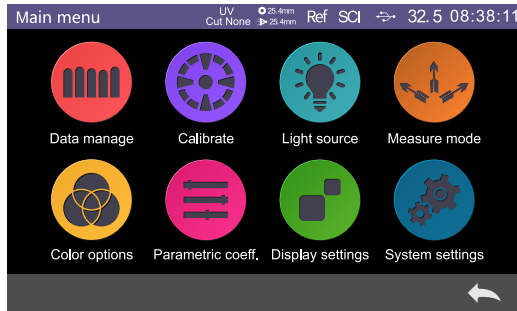

Figure 3 Main Menu

2、 Click “Calibrate” to enter white and black calibration interface as shown in Figure 4. It will show whether the calibration is valid or not and how long the remaining time is.

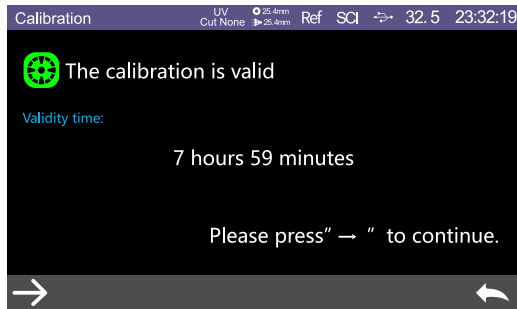



Figure 4 Black and White Calibration

Benchtop Spectrophotometer

- Click  to enter Reflective Black Calibration interface as shown in Figure 5.
- Place the black cavity well according to the warning, then press the test key to start black calibration, or click  to quit the calibration.

Steps for placing black cavity:

- Pull out the sample holder.
- Place the black cavity to joint with groove of instrument, then close the sample clamp to fasten the black cavity.

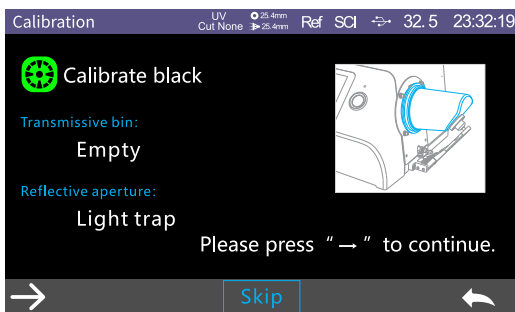



Figure 5 Reflective Black Calibration Interface

- It will automatically enter White Calibration after Black Calibration is finished as shown in Figure 6. Place well white plate (same steps as how to place black cavity), then press test key to start white calibration, or click  to quit the white calibration.

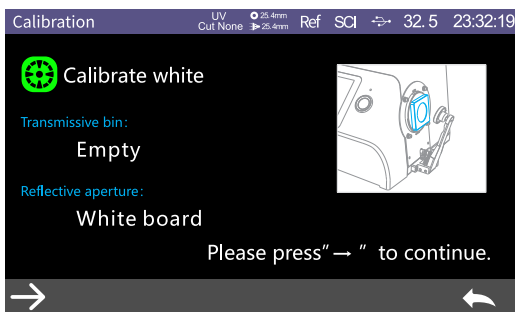

Figure 6 Reflective White Calibration

After black and white calibration are finished rightly, the instrument system will reset remaining time according to valid time since last calibration (As shown in Figure 4).

The opacity measuring mode is based on the reflection , so its calibration is same as reflect white and black calibration.

2.2.2 Transmission Measurement Mode Calibration

First of all, ensure instrument is in Transmission Measuring Mode (For specific setting please refer to section 3.4)

Cautions: During transmission measuring mode, no matter if it's during calibration or measurement mode, please ensure the reflective measuring aperture is $\Phi 25.4\text{mm}$, and fasten the reflection plate to the reflective measuring aperture.

Calibration Steps:

- 1、 Enter into main menu as shown in Figure 3, click “Calibrate” to enter 0% calibration. Place the transmission black plate into transmission sample bin and stick it to the side of integrating sphere tightly, close the cover, and click the test key to start calibration.as shown in Figure 7.
- 2、 After finishing 0% calibration, enter 100% calibration ,take out the black plate, place the white calibration reference according to prompt, ensure it stick to the side of integrating sphere tightly, close the bin cover, and press test key to start calibration.as shown in Figure 8.

Benchtop Spectrophotometer

Cautions:

The users should choose relative white calibration reference according to different type of transmissive tested sample. For example, if tested sample is plastic or glass etc, air can be chosen as white calibration reference. If tested sample is liquid, then a cuvette filled with deionized water or distilled water can be used as a reference for white calibration. If the tested sample is powder packed in a cuvette, then an empty cuvette can be selected as a reference for white calibration. Of course, users can also choose the standard solution that has been calibrated (e.g. Potassium Permanganate solution with calibrated transmissivity) as a reference. Calibration channels should be chosen relatively for different calibration reference.

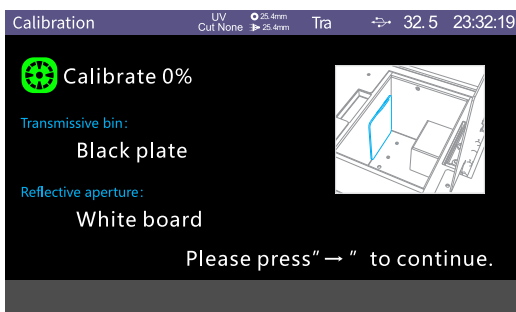

Figure 7 Transmission Black Calibration

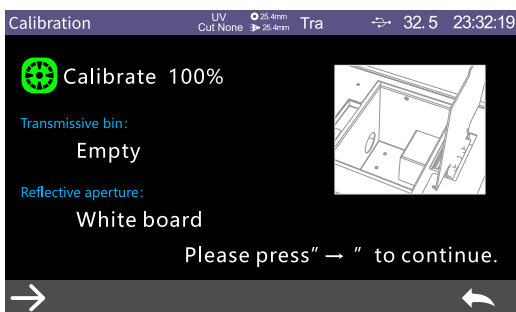



Figure 8 100% Calibration

After finishing of calibration rightly, the instrument system will reset remaining time according to valid time since last calibration (As shown in Figure 4).

2.2.3 Haze Measurement Mode Calibration

First of all, ensure instrument is in Haze Measuring Mode (For specific setting please refer to section 3.4)

Calibration Steps:

- 1、 Enter the main menu as shown in Figure 3, click “Calibrate” to enter 0% calibration. Place the transmission black plate into transmission sample bin and stick it to the side of integrating sphere tightly, close the cover, and click the test key to start calibration.as shown in Figure 7.
- 2、 After finishing 0% calibration, enter 100% calibration ,take out the black plate, place the white calibration reference according to prompt, close the bin cover, and press test key to start calibration.as shown in Figure 8.
- 3、 After finishing 100% calibration, enter figure 9 interface , place the black cavity according to prompt, and press test key to start calibration.as shown in Figure 9.
- 4、 It will automatically enter White Calibration after Black Calibration is finished as shown in Figure 10. Place well white plate (the same step as how to place black cavity), then press test key to start white calibration, or click  to cancel and quit the white calibration.

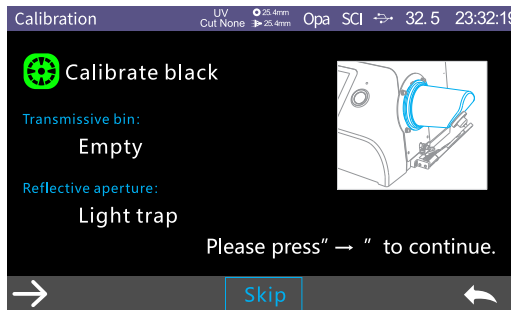

Figure 9

Benchtop Spectrophotometer

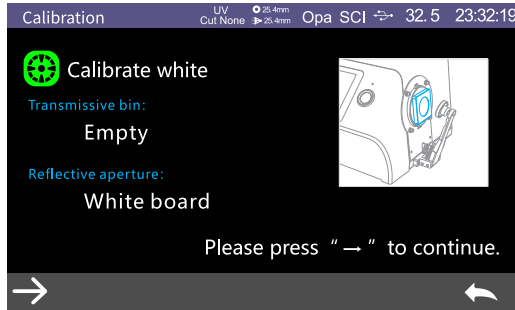

Figure 10

2.3 Measurement

2.3.1 Measurement Instruction

As shown in Figure 11, it is working condition area at the top of measurement interface, displaying the status of measurement mode, including: Interface Name, USB Connection status, System time, Simulation color, Aperture dimension, Lens position, Measuring mode and so on.

At the left side, it is shortcut area, it could switch different modes by touching different icons.

At the middle, it displays different chromatic data according to different setting of color formulas.

It is operation buttons area at the bottom, which could operate the data by touching the different icons.

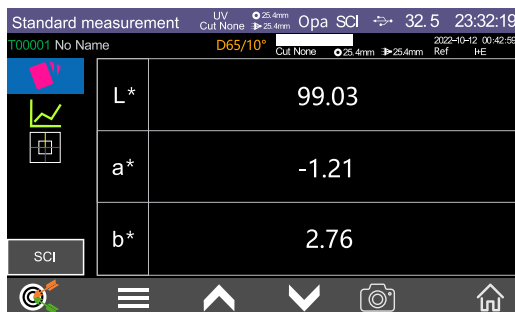



Figure 11 Colorimetric Measure

Benchtop Spectrophotometer

Figure 12 is the interface of reflectance rate spectrum. Figure 13 is colorimetric index display area, fast switching by touching the   icon.

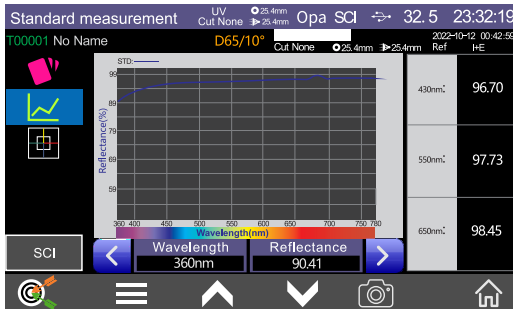

Figure 12 Reflectance Spectrum

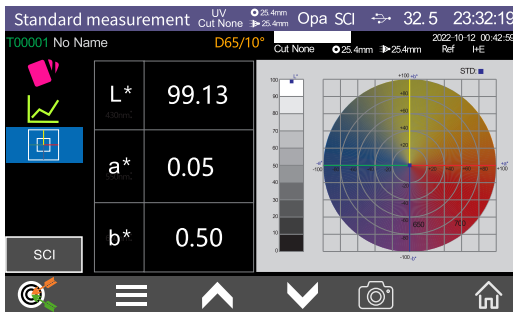













Figure 13 Colorimetric index

Standard measuring interface instruction

- (1) Interface Title: indicate the current interface name;
- (2) Status Bar: display the current device temperature, Bluetooth working status, USB communication status, system time, etc.
- (3) Standard simulation color: the corresponding color of standard test results;
- (4) Standard ID, Standard Code
- (5) Aperture: the aperture of the current system;
- (6) Lens: the lens position of the current system;
- (7) Sample measurement type: the measurement method set by the current system includes reflection, transmission, haze and opacity .

Benchtop Spectrophotometer

- (8) Sample measurement mode: it is able to choose SCI, SCE, or I + E , If set only SCI or SCE , the switch cannot be performed
- (9) Display mode: click  or  to switch the current mode of data display. Opacity measurement mode : click  or  to switch for data display.
- (10) Name of standard sample: showing the name of the current tested sample. Click to modify quickly.
- (11) Switch to sample measurement: click  to enter the sample measurement interface.
- (12) Data switching: click  switch to the previous set of data,click  switch to next set of data.
- (13) Spectrum display : click  to check current spectrum data.
- (14) Color space: by clicking the shortcut key, the current test data can be quickly switched between CIE Lab, CIE XYZ, CIE Yxy, CIE LCh and other color spaces.
- (15) Camera locating: click  to view the position of the object to be measured at the reflective measurement aperture
- (16) Wavelength switch button: Click  or  button to switch the wavelength of the light wave, the reflectance of the sample and the reflectance difference of the tested sample at the interval of 10nm, as shown in Figure 22.
- (17) Specify wavelength: Click the wavelength data to select the specified wavelength, as shown in Figure 16;
- (18) Sub-menu : Click , the options: lock, rename, print, set tolerance, delete, exit, as shown in Figure 15.

Benchtop Spectrophotometer

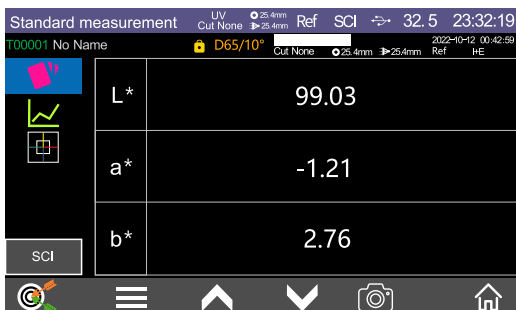



Figure 14 Standard Measurement Interface

The standard measuring interface instructions :

- (1) Tolerance setting: Click to set the standard sample tolerance of the current standard sample; if not set, the system tolerance will default. please refer to the 2.7.1
- (2) Locking: Lock the current standard sample
- (3) Rename: Modify the name of the standard sample
- (4) Printing: Print the data;
- (5) Delete: Click  choose "Delete", delete the current record, automatic storage is enabled by default. If automatic storage is turn off, "Storage" is displayed. Refer to 3.8.1 Automatic Storage section.
- (6) Exit: exit the menu and return to the standard sample measurement interface;

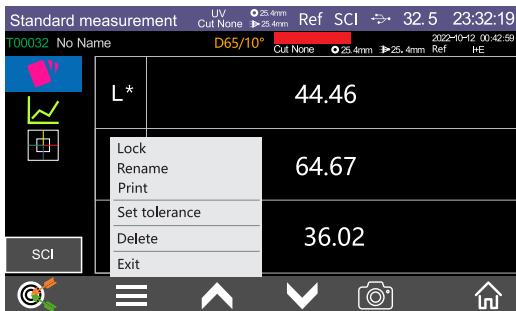

Figure 15 Standard Measurement

Benchtop Spectrophotometer

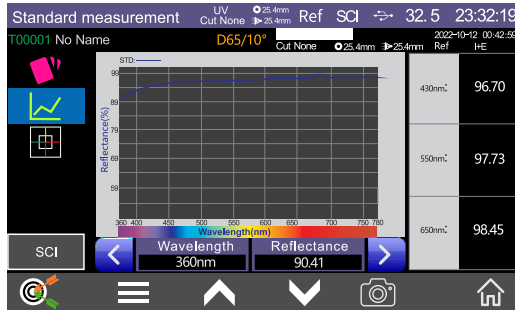

Figure 16 Spectra of standard samples

Description of the difference between the interface of sample measurement and standard measurement:

- (1) Name of standard sample: ID of the standard sample corresponding to the sample;
- (2) Sample ID: Sample code;
- (3) Name of sample :the name of the current sample being tested can be quickly modified by clicking.
- (4) Simulation color: the simulation color of the current standard sample is displayed on the left of the simulation area, the current sample simulation color is displayed on the right.
- (5) Sample chromaticity data: the chromaticity data of the current sample is displayed on the left , and the chromaticity data difference between the current sample and the standard sample is displayed on the right side of the display area;
- (6) Test result: according to the tolerance of the standard sample and the specified color difference formula, when the color difference exceeds the tolerance, the red will show "not pass", otherwise the green will show "pass". It is displayed only when "Display Results" is enabled in system Settings.
- (7) Color deviation: Color deviation of the current standard sample compared with the sample. It is displayed only when "Color deviation" is enabled in system settings.
- (8) Color Index: Switch to the Color index screen.

Benchtop Spectrophotometer

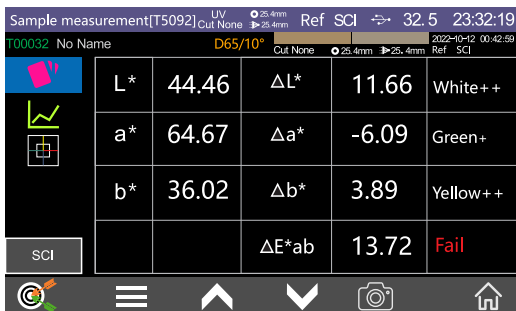

Figure 17

The submenu of sample measurement is similar to the submenu of standard sample measurement, but there are some differences. as shown in Figure 18

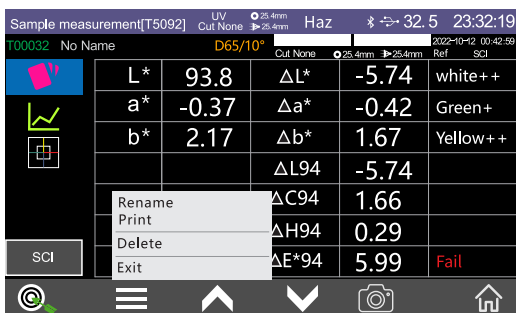

Figure 18

2.4 Measurement Settings

2.4.1 Average Measurement

When the tested object is relatively large, or the chromaticity is relatively uneven, the multi-points average reflectance is obtained by measuring a plurality of representative test points, and then the calculated chromaticity data is more representative of the true color of the tested sample. the instrument can achieve 1~10 times average measurement, and the average number of measurements can be set for 1~30 times both samples and standards. Automatic average: After setting the number of times, the measurement is automatically averaged according to the set number of times.

Average measurement of standard and sample: After setting the number of times, average measurement is carried out step by step according to the set number.

Click “Measurement Mode” on the main menu, then click “Average Measurement” to enter the average measurement setting interface, as shown in Figure 19:

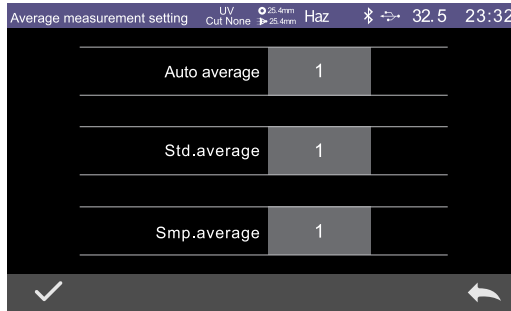

Figure 19 Setting Interface of Average Measurement

2.4.2 Continuous Measurement

When the test condition is fixed and the sample is required to be continuously measured, or in the automated production line operation process, continuous measurement mode can be used to reduce the operation and save test time. Both the standard measurement and the sample measurement can be set the number of consecutive measurements and the time between each measurement interval, and save each measurement result. during continuous measurement, continuous measurement can be terminated by pressing the measurement button.

Click the measurement mode on the main menu, and then click “Continuous Measurement” to enter the continuous measurement setting interface, as shown in Figure 20:

Benchtop Spectrophotometer

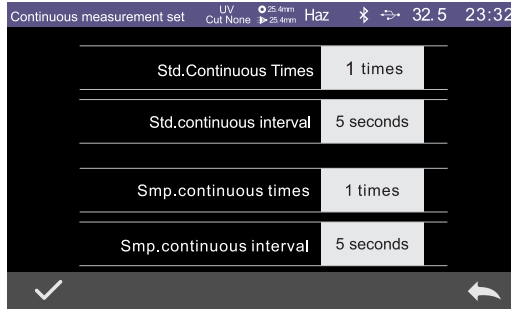

Figure 20 Continuous Measurement Mode Setting Interface

2.5 Measurement

2.5.1 Reflection Standard /Sample Measurement

Reflection Standard /Sample Measurement steps

1、 Set the current measurement mode to reflection measurement mode (refer to section 3.4 for details)

2、 Set the corresponding measuring aperture:

Menu→Measurement mode→aperture/ lens position, Enter the interface as shown in Figure 21, you can manually select the corresponding measuring aperture and lens position (default automatic mode).

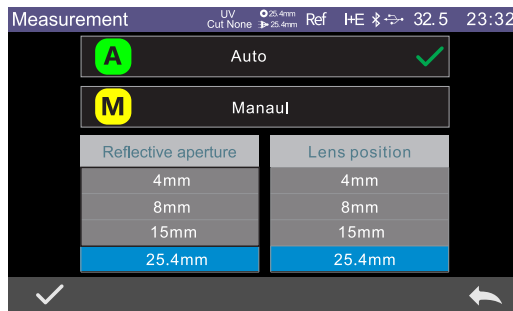

Figure 21 aperture / lens position

3、 Light source settings

Menu→Light source, Enter the interface as shown in Figure 22, click " ✓ " to confirmation.

Benchtop Spectrophotometer

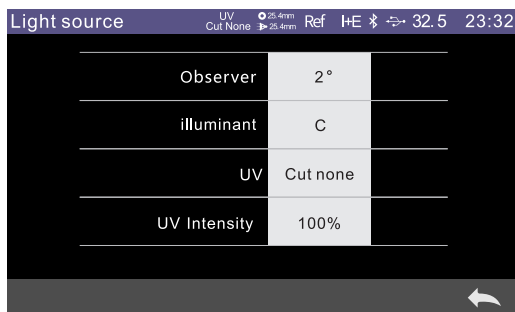



Figure 22 Light source settings

When the UV light source changes, it needs to be re-corrected in black and white calibration (refer to section 2.2.2).

The Standard sample measurement :

Enter the standard sample measurement interface (FIG. 2) after the above preparation are completed, put the tested sample at the reflection test port of the instrument, press the measurement key to start the measurement, and the buzzer will make a "drop" sound, while the LED indicator will blink, until the flashing stops, the buzzer will make a "drop" sound again, that is, the measurement is completed. that interface is shown in Figure 14, Figure 15 and Figure 16.

Reflection sample measurement is similar to reflection standard sample measurement

On reflection sample measurement interface ,click "  " switch to sample mode measurement ,press the measurement key to start testing , the interface as shown in Figure 17.

2.5.2 Transmission Standard/Sample Measurement

Steps to standard measurement of transmissive sample:

- 1、 Set the current measurement mode to the transmissive measurement mode (refer to Section 3.4 for specific settings).
- 2、 Set the corresponding aperture.

There is only automatic mode for aperture size/lens position in transmissive measurement mode and it can't be set manually. But the reflective measurement aperture should be only 25.4mm, and the white board is placed to the aperture.

- 3、 Set the light source (the same as the reflective standard measurement).
- 4、 If any parameter settings changed, it needs to redo the transmissive black and white calibration (Refer to section 2.2.2).

5、 Standard Measurement of Transmissive Sample

Return to the standard measurement of transmissive sample interface, place the sample in the transmissive sample compartment, cling to the measurement aperture, and close the sample compartment cover. short press the measurement button to start the measurement, the transmission data is displayed in the color index interface.

Transmission sample measurement is similar to transmission standard sample measurement

2.5.3 Haze Standard / Sample Measurement

Haze is a colorimetric indicator of transmission measurement. it is an objective measure of total transmittance and transmission haze according to international indicators, used for measurement of haze values of all transparent, translucent parallel flat samples.(such as plastic sheets, sheets, plastic films, flat glass.) It has a wide range of applications in national defense research and industrial and agricultural production.

When the white board is positioned on the reflection measurement aperture, the measurement geometry of transmission becomes $d_i: 0^\circ$; When the reflection black cavity (instrument 0 reference) is positioned on the reflection measurement aperture, the measurement geometry of the transmission measurement changes to $d_e: 0^\circ$. The haze value needs to be used as a reference in both cases.

Haze target measurement steps:

- 1、 Set the current measurement mode to the haze measurement mode (refer to Section 3.4 for specific Settings)

Benchtop Spectrophotometer

2、 Set measuring aperture:

Only manual mode is available for measuring aperture/lens position in transmission measurement mode. Make sure that only 25.4mm is available for reflection measurement.

3、 Set the light sources

4、 Re-calibrate the black and white correction (see section 2.2.4).

5、 Return to the haze measurement interface.

6、 According to the measurement prompts , perform the operation, and the haze measurement can be completed.the haze data will displayed in the interface, as shown in Figure 23.

Haze measurement interface refer to figure 24, 25

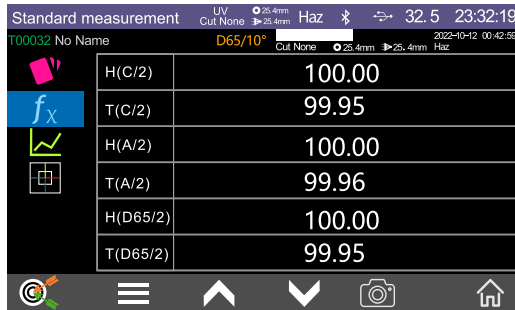

Figure 23 Haze measurement

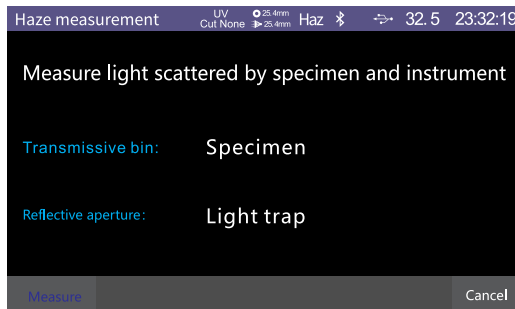

Figure 24 Haze measurement

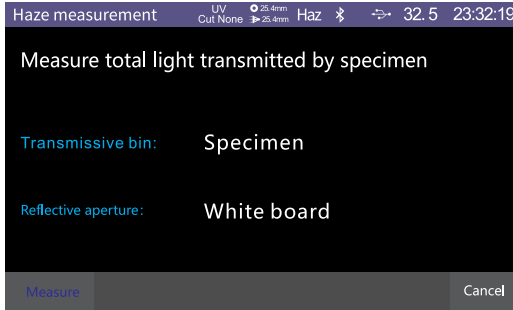

Figure 25 Haze measurement

Haze sample measurement: Haze sample measurement is similar to haze target standard measurement.

2.5.4 Opacity target /sample measurement

Opacity measurement has a wide range of applications, such as the paint , paper industry and others. Under certain conditions (price, thickness, etc.), people usually want materials with high opacity as it means high relatively good quality.

Opacity target measurement steps :

- 1、 Set the current measurement mode to the coverage measurement mode (refer to Section 3.4 for specific Settings)
- 2、 Set the measurement mode: the opacity measurement can only choose SCI or SCE, I+E mode can not be chosen.
- 3、 Set the corresponding measuring aperture
Main menu→Measurement mode→Measure aperture/lens position ,enter the interface as shown in Figure 21, you can manually select the corresponding measuring aperture and lens position (default automatic mode).
- 4、 Set the light sources:
Main menu→light sources setting,enter the setting interface as shown in Figure 21 ,according to the demands to set the corresponding light source options and click “ ✓ ”to confirm.

- 5、 Re-calibrate black and white (see section 2.2.4)
- 6、 Return to the opacity measurement interface
- 7、 According to the opacity measurement prompts , perform the operation, and once the opacity measurement completed.the opacity data will displayed in the interface, as shown in Figure 26,27,28

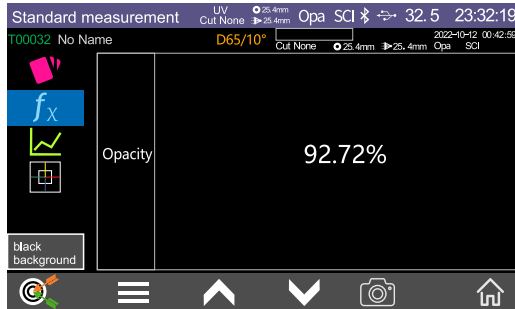

Figure 26 Opacity Measurement interface

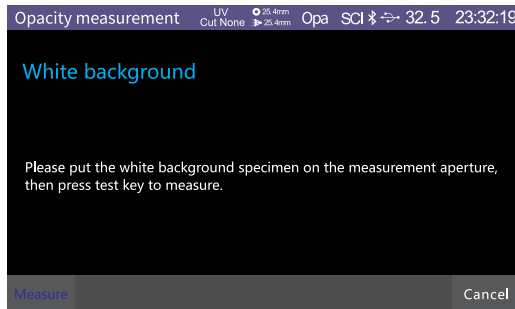

Figure 27 Opacity Measurement white background

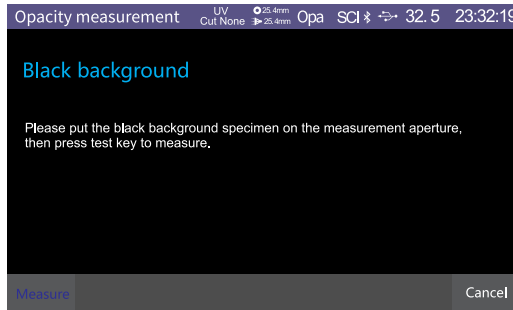



Figure 28 Opacity Measurement Black ground interface

2.6 CONNECTION TO PC

The PC-side color management software has many functions to realize richer chroma data analysis. The instrument can communicate with the installed PC-side color management software via USB or Bluetooth module (only for product models equipped with Bluetooth modules).

2.6.1 USB Connection

When the color management software is installed on the PC, use USB cable to connect the instrument to the PC. The software will automatically connect to the instrument. If the connection is successful, the status bar of the instrument will display the USB connection icon . Through the PC color management software, it can achieve complete control of the terminal instrument, and related sample testing and analysis.

2.6.2 Bluetooth Connection

With Bluetooth-equipped instruments, first turn on the Bluetooth function in the system settings, open Bluetooth on the Bluetooth-enabled PC, search for devices such as 3nh-ble-device-01, and fill in the matching code to connect. If the connection is successful, the status bar of the instrument will display the Bluetooth connection icon , then through the PC-side color management software, it can achieve complete control of the terminal instrument, and related sample testing and analysis.

2.7 TOLERANCE SETTING

The tolerance is for the standard, and the tolerance of the standard will affect the instrument's determination of the sample result. System tolerance is the tolerance that the instrument assigns to the standard by default. If the standard tolerance is not set, the system tolerance will be used by default, so the accuracy of the system tolerance is critical to the accuracy of the test result judgement.

2.7.1 System Tolerance Setting

From the main menu, enter the system setting interface (Figure 29), click ▼ to find the system tolerance, click on the "System Tolerance" to the editing interface, as shown in Figure 30:

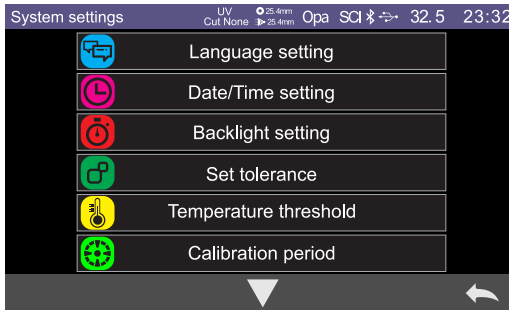



Figure 29 System Setting Interface



Figure 30 Interface of System Tolerance Settings

The total tolerance of the standard is set in the interface ΔE^* (CIE1976)

The left side ΔL^* is the lower limit of the set standard tolerance, the right side ΔL^* is the upper limit of the set standard tolerance, and the upper limit of the right tolerance must be greater than the lower limit of the tolerance. the setting method Δa^* and Δb^* is the same as ΔL^* ,Click the corresponding tolerance value to enter the corresponding value setting interface. After setting, click  to confirm the saving, and this means the tolerance is the standard or click the lower side  to cancel and exit the tolerance setting interface.

When the standard uses the default system tolerance, the sample is compared with the standard data, and only if the tolerance ΔE^* , ΔL^* , Δa^* , Δb^* is within the tolerance range, the sample will be Pass, or the prompt will be Fail (turn on the test result prompts the function).

2.7.2 Standard Tolerance Setting

Standard measurement interface (Figure 2) Click "Standard Tolerance" to enter the editing interface, as shown in Figure 31.

In the measurement interface, click the  submenu and choose "Set tolerance", that is, you can modify the tolerance of the standard sample. The setting interface and method are the same as the system tolerance setting, But the standard sample tolerance can only modify and store under the corresponding current measurement conditions, the current standard tolerance setting will not be available If the current measurement conditions are changed, then the system tolerance is still used in the measuring judgment.







Figure 31 Interface of Standard Tolerance Settings

2.8 PRINT

There are two ways to print the sample chromaticity data of the instrument. One is to print it through the printer connected to the PC software when connecting the PC to the color management software; the other is to print by a micro printer connected to the instrument, and this way is described in detail below. Micro-printers are non-standard accessories and required to be purchased separately.

Printing steps:

- 1、 First test the standard and save the test record to print;
- 2、 Enter "System Settings" from the main menu, click "Print Data" to open this function;
- 3、 If "automatic printing" is set to "on", each measured sample will automatically print out;
- 4、 Connect the micro printer to the instrument via USB or Bluetooth (Bluetooth printer required); Bluetooth print Settings are shown in Figure 32. Click  search to select the device;
- 5、 Enter "Data Management" from the main menu, view the record, and find the sample record (standard record or sample record) to be printed by  or 
- 6、 Click  to select "Print" in the pop-up menu (as shown in Figure 33), then start to print the sample, the content of the print will be different

Benchtop Spectrophotometer

according to the page currently displayed; the test results are automatically printed after each sample is measured. If automatic printing is selected in system

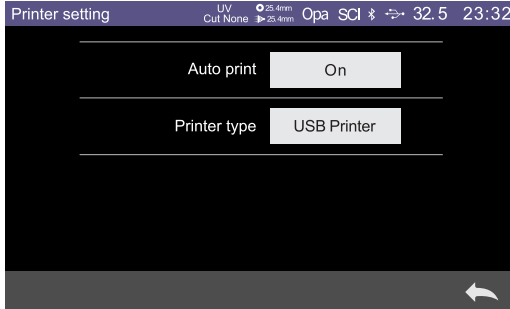

Figure 32 Printing setting

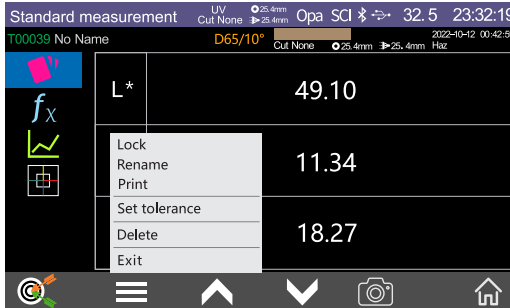



Figure 33 Printing Interface

3. System Functions

In the measurement interface (Figure 2) click  to enter the main menu, or click  in other interfaces to enter the main menu. From the main menu, it can enter each sub-menu to achieve all system function settings.

3.1 Data Management

Click “Data Management” on the main menu interface to enter the data management interface, as shown in Figure34. Data management can realize functions such as “Check Record”, “Delete Record”, “Search Record” and

“Standard Input”.

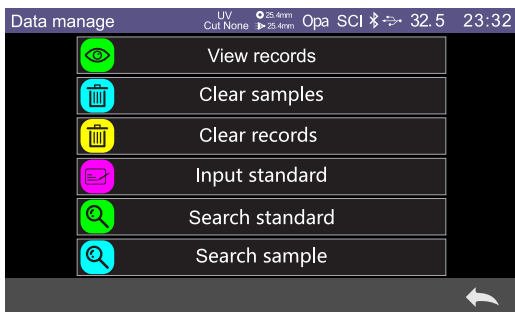

Figure 34 Data Management

3.1.1 Check Record

(1) Check Standard Record



Click "Check Record" to enter the "Standard Record" interface in the data management interface. As shown in Figure 35.

The screenshot shows a mobile application interface titled "View standards". At the top, there is a status bar with "UV", "Cut None", "25.4nm", "25.4nm", "Ref", "SCI", "32.5", and "23:32". Below the status bar is a table with the following data:

| ID/Color | Time/Name | L* | a* | b* | Condition |
|----------|---------------------|-------|-------|-------|----------------|
| T00001 | 2022-11-21 15:44:16 | 97.53 | -0.38 | 2.25 | Ref 25.4nm SCI |
| T00002 | 2022-11-21 15:51:35 | 34.34 | 26.16 | 12.89 | Ref 25.4nm SCI |
| T00003 | 2022-11-21 15:51:40 | 59.61 | 5.16 | 21.75 | Ref 25.4nm SCI |
| T00004 | 2022-11-21 15:52:18 | 45.98 | 64.24 | 36.93 | Ref 25.4nm SCI |
| T00005 | 2022-11-21 15:52:20 | 97.53 | -0.38 | 2.25 | Ref 25.4nm SCI |
| T00006 | 2022-11-21 15:52:54 | 34.00 | 26.00 | 12.81 | Ref 25.4nm SCI |

At the bottom of the screen, there is a navigation bar with a menu icon (three horizontal lines), an up arrow, "1/2", a down arrow, and a back arrow.

Figure 35 Standard Record

- Switch records by clicking  or 
- Click  to view the sample interface menu, Click "Delete" again to enter the record deletion reminder interface, as shown in Figure 37. Click "Yes" to confirm deletion; Click "No" to cancel the deletion and return to the "View Standards" interface

Benchtop Spectrophotometer

| ID/Color | Time/Name | L* | a* | b* | Condition |
|----------|---------------------|-------|-------|-------|----------------|
| T00001 | 2022-11-21 15:44:16 | 97.53 | -0.38 | 2.25 | Ref 25.4mm SCI |
| T00002 | 2022-11-21 15:51:35 | 34.34 | 26.16 | 12.89 | Ref 25.4mm SCI |
| T00003 | 2022-11-21 15:51:40 | 59.61 | 5.16 | 21.75 | Ref 25.4mm SCI |
| T00004 | 2022-11-21 15:52:18 | 45.98 | 64.24 | 36.93 | Ref 25.4mm SCI |
| T00005 | 2022-11-21 15:52:20 | 97.53 | -0.38 | 2.25 | Ref 25.4mm SCI |
| T00006 | 2022-11-21 15:52:54 | 34.00 | 26.00 | 12.81 | Ref 25.4mm SCI |

Figure 36 Standards record interface

| ID/Color | Time/Name | L* | a* | b* | Condition |
|----------|---------------------|-------|-------|-------|----------------|
| T00001 | 2022-11-21 15:44:16 | 97.53 | -0.38 | 2.25 | Ref 25.4mm SCI |
| T00002 | 2022-11-21 15:51:35 | 34.34 | 26.16 | 12.89 | Ref 25.4mm SCI |
| T00003 | 2022-11-21 15:51:40 | 59.61 | 5.16 | 21.75 | Ref 25.4mm SCI |
| T00004 | 2022-11-21 15:52:18 | 45.98 | 64.24 | 36.93 | Ref 25.4mm SCI |
| T00005 | 2022-11-21 15:52:20 | 97.53 | -0.38 | 2.25 | Ref 25.4mm SCI |
| T00006 | 2022-11-21 15:52:54 | 34.00 | 26.00 | 12.81 | Ref 25.4mm SCI |

Figure 37 Delete Record

Edit the current viewing standard record name: Click  to view the standards submenu, and then click "Rename" to enter the name editing interface, enter the new name, press "Yes" to confirm the saving, and click "Cancel" to cancel the name editing operation, as shown in Figure 38.

View standards UV Cut None 25.4mm 25.4mm Ref SCI 32.5 23:32:19

Please input record name Clear

1 2 @ 3 # 4 , 5 % 6 ^ 7 & * 8 () 0

q w e r t y u i o p



a s d f g h j k l

shift z x c v b n m

Cancel / Space - Done



Figure 38 Edit Nam

Benchtop Spectrophotometer

Set the viewing standard as the current standard: Click  to view the standards submenu, then click "Export", you can set the current standard record being viewed as the current standard, next click  to perform the sample measurement under this standard.

Reset the current viewing standard record: Click  to view the standards submenu then click "Replace" to remeasure and replace the viewing standard record. The interface switches to standard measurement and short press the measurement button to remeasure.

(2) Check Sample Record

(3) Click  to view the sample interface menu and then click "View sample" to switch to the sample record interface to view the sample record corresponding to the standard sample. In the sample recording interface, you can click  to return to the standard sample recording interface, as shown in Figure 39 and Figure 40

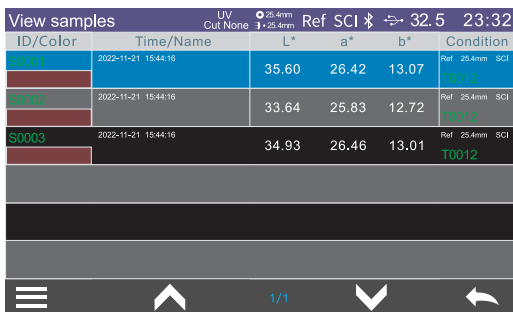

| ID/Color | Time/Name | L* | a* | b* | Condition |
|----------|---------------------|-------|-------|-------|-------------------------|
| S0001 | 2022-11-21 15:44:16 | 35.60 | 26.42 | 13.07 | Ref 25.4mm SCI T0012 |
| S0002 | 2022-11-21 15:44:16 | 33.64 | 25.83 | 12.72 | Ref 25.4mm SCI T0012 |
| S0003 | 2022-11-21 15:44:16 | 34.93 | 26.46 | 13.01 | Ref 25.4mm SCI T0012 |

Figure 39 Check Sample Record

Benchtop Spectrophotometer

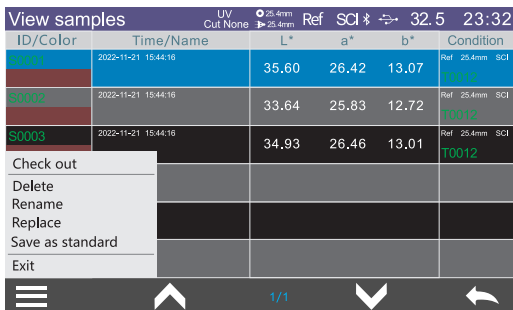

Figure 40 View samples

3.1.2 Delete Record

In the data management interface, as shown in Figure 34. Delete options are: "Delete sample" and "Delete record"

Click the corresponding option to enter the warning interface of deletion prompt. Click "Yes" in the warning interface to delete all the corresponding records; Click "No" to cancel the deletion, as shown in Figure 41.

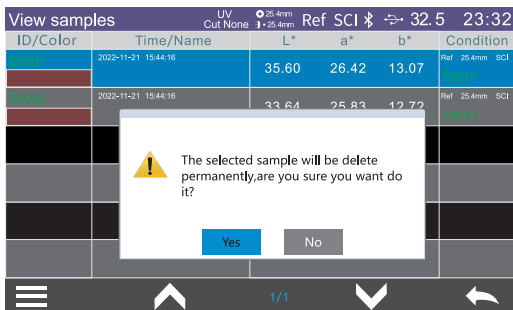

Figure 41 Delete Record

3.1.3 Search Record

The data management interface is shown in Figure 34. Select "Search Standard" and "Search Sample". Search by entering the time range and name, as shown in figure 42; click to enter the interface for searching sample name, as shown in figure 43; in "Searching sample", you can search globally or only

Benchtop Spectrophotometer

sample under a certain standard, as shown in figure. 44; click the sample ID to enter the ID number of the sample, as shown in Figure 45. Figure 31 Search Record.

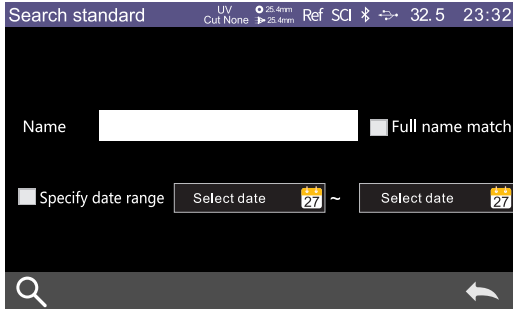

Figure 42 Standard Search

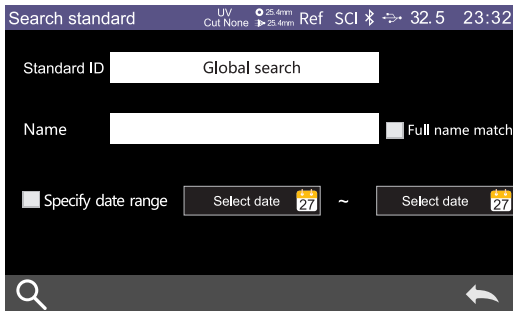

Figure 43 Standard Search

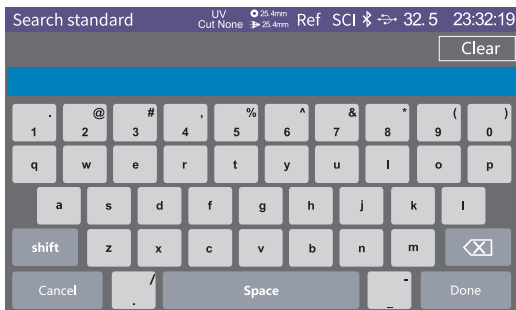

Figure 44 Standard Search

Benchtop Spectrophotometer

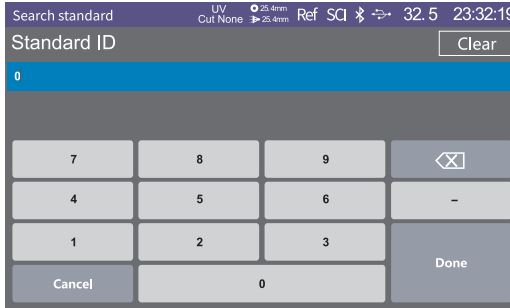

Figure 45 Standard ID Search

3.1.4 Standard Input

Click "Standard Input" to enter standard inputting interface, different input interfaces will be displayed according to the sample type, color space and measurement mode currently set. In addition, the standard sample cannot be entered in some color Spaces, which will be prompted in specific using.

As figure 46 shows the interface of input standard samples in CIE Lab color space under I+E mode. the input under other settings is similar:

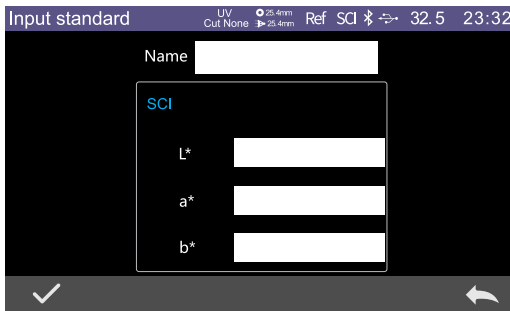

Figure 46 Standard Input

Click standard name to input standard name.

Click the corresponding chromaticity coordinate value to input the chromaticity value of the corresponding coordinate. Input all standard information and click

to confirm then the standard is saved in the standard record list, whose standard number ID is added in order.

3.2 White And Black Calibration

As the basis of chromaticity measurement, black and white calibration must be carried out accurately, or it will affect the validity of test data.

When the current black and white calibration environment is greatly different from the current sample test environment (such as temperature drastic fluctuation), the instrument is required to be re-calibrated in time. After the last successful black and white calibration exceeds the setting time, it is also recommended to redo black and white calibration before the measurement.

3.3 Light Source

The user can set the corresponding light source according to the actual test condition. It can set the system standard observer angle, standard light source type and UV light source opening in this light source setting interface.

Click "Illuminant" to enter light source setting on the main menu (Figure 22). Click observer angle to switch between 10° and 2°. 10° is CIE1964 standard. 2° is CIE1931 standard.

Click "Illuminant" as shown in Figure 47. In the Illuminant option window, D65, A, C, D50, D55, F1~F12 and other light sources can be selected.

Click UV light source to switch UV light source mode. 400 CUT means that light source filtered the 360-400nm spectral components through the filter. 420 CUT means that light source filtered the 360-420nm spectral components through the filter. 460 CUT means that light source filtered the 360-460nm spectral components through the filter. CUT NONE means light source without filter and full spectrum lighting between 360-780nm. There is a little difference among different product types.

Benchtop Spectrophotometer

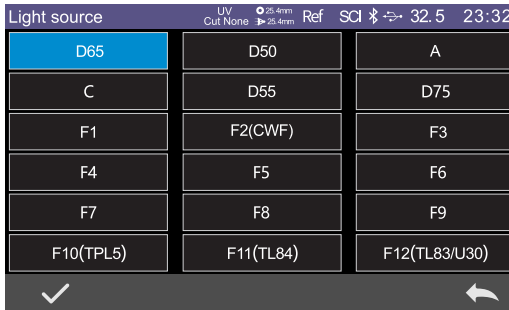

Figure 47 Illuminant

3.4 Measurement Mode

Clicks "Measure Mode" on the main menu to enter this interface, which includes Reflective/Transmissive Measure, Aperture size/lens position, Average Measurement, Continue Measure, Sample Measure Mode as shown in Figure 48.

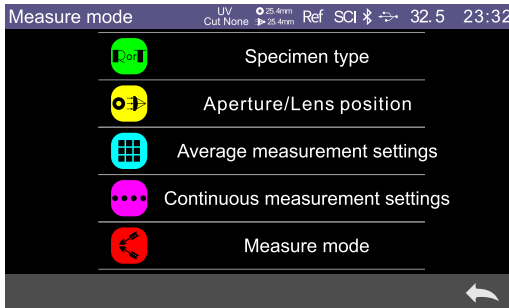

Figure 48 Measure Mode

After entering Reflective/Transmissive Measure, Reflective Measure/Transmissive/ Haze/Opacity Measure can be selected as shown in Figure 49.

Benchtop Spectrophotometer

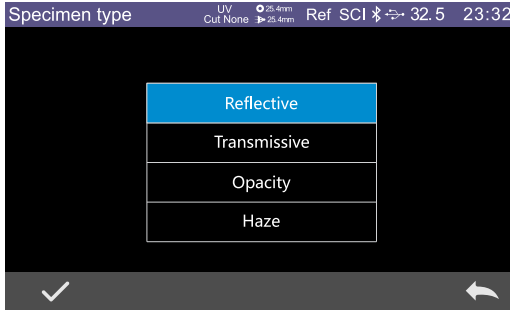

Figure 49 Reflective/Transmissive /Opacity /HazeMode Select

When Transmissive Measure is selected, the main measurement interface displays T%, representing the current Measure Mode as Transmissive

What needs to be emphasized here is that black and white calibration is required every time when switches between Reflective Measure and Transmissive Measure. Please refer to section 2.2 for black and white calibration.

Aperture size/lens position can be set as automatic recognition and manual mode. When the user changes the aperture, the instrument will recognize the aperture size according to the image of the camera and adjust lens place under the automatic recognition. The user also can set aperture size and adjust lens position under manual mode. The instrument defaults as automatic mode as shown in Figure 50.

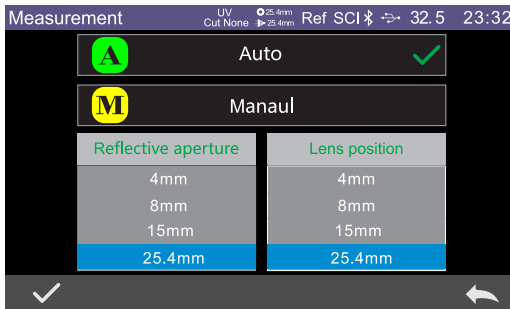

Figure 50 Aperture size/lens position

Benchtop Spectrophotometer

Note: Only manual mode is supported in transmission mode, and the reflected aperture is fixed at 25.4mm, and the transmission aperture size needs to be manually specified according to the installed transmission aperture clamp.

3.5 Color Options

In the main menu, click “Color Options” to enter the color options interface color space, color diff formula, and chromaticity index, as shown in Figure 51.

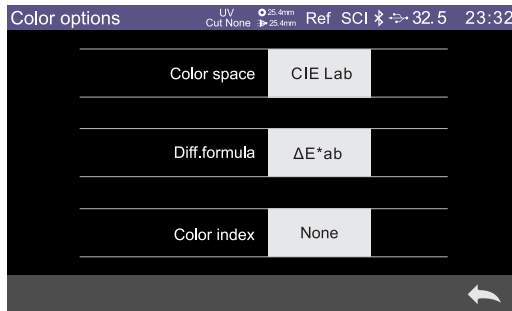

Figure 51 Color Space Interface

3.5.1 Color Space

In the main menu, click “Color Space” to enter the color space interface as shown in Figure 51, select the corresponding color space there, and then click to confirm the setting.

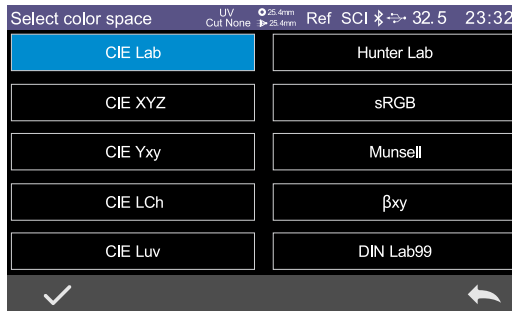

Figure 52 Color Space Selection Interface

3.5.2 Color Formula

When set the Color Diff Formula, the user can choose ΔE^* , $\Delta E_{cmc}(2:1)$, ΔE_{94} , $\Delta E_{cmc}(1:c)$, etc. After selecting, click to confirm the Color Diff Formula, as shown in Figure 53.

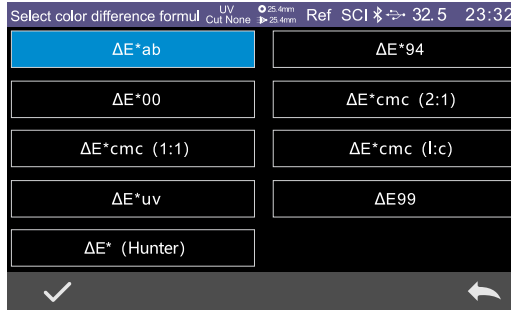

Figure 53 Color Formula Interface

3.5.3 Color Index

After the chromaticity index is set, the selected color index will be displayed in the color index of the standard and sample measurement (depending on the index, part of the index is only displayed in the sample and is also affected by the type of transmission and reflection). Click **f_x** on the measurement interface to the color index display area, as shown in Figure 54 for Whiteness Display Interface.

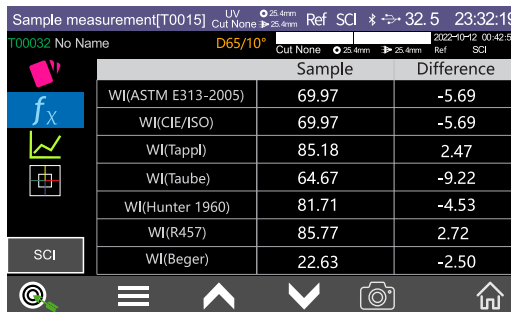

Figure 54 Whiteness Display Interface

3.6 Parametric Settings

Click "Parameter Setting" to enter the parameter setting interface. you can select parameter factor: color difference formula, MI index setting, Yellowness and whiteness ; 555 Shade sorting, Strength, Haze, as shown in Figure 55:

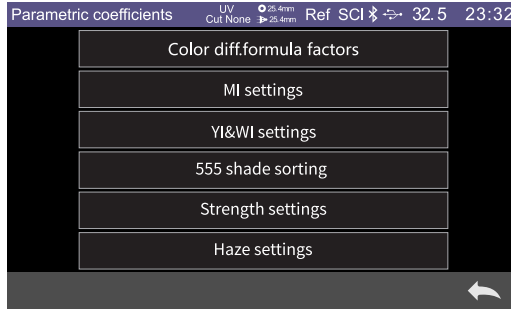

Figure 55 Parameter Factor Setting Interface

Click "Color diff.formula factors" you can set the factors ΔE^*94 , ΔE^*00 , $\Delta E^*cmc(l:c)$ as shown in Figure 56.



Figure 56 Color diff formula Factors Setting Interface

Click "MI settings" you can set Standard light sources and observer angles for reference 1 and reference 2. as shown in Figure 57

Benchtop Spectrophotometer

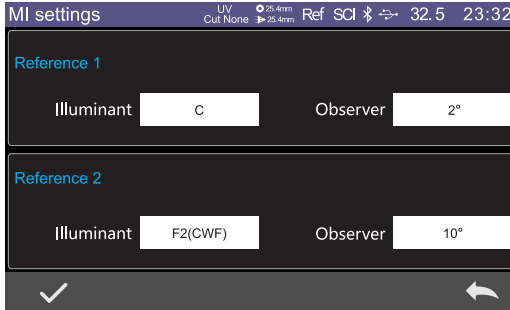

Figure 57 ,MI Factors Setting Interface

Click “YI&WI Factor settings” you can set choose the standard of YI or WI. as shown in Figure 58.

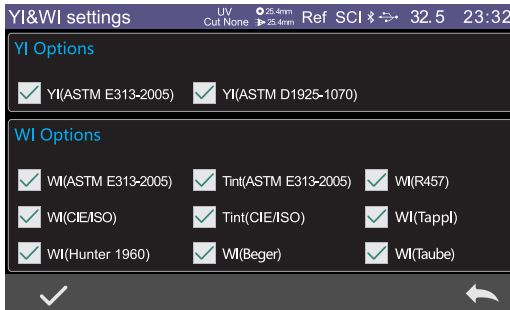

Figure 58 YI&WI Factor setting interface

Click “555 Shade sorting” you can choose the color scales for sorting and set the tolerance . as shown in Figure 59.

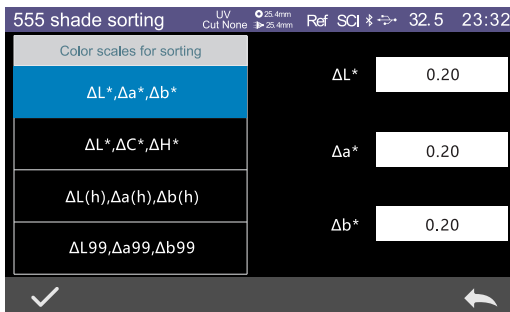

Figure 59 555 Shade sorting setting interface

Benchtop Spectrophotometer

Click “Strength settings” you can choose the type and the specified wavelength point, as shown in Figure 60.

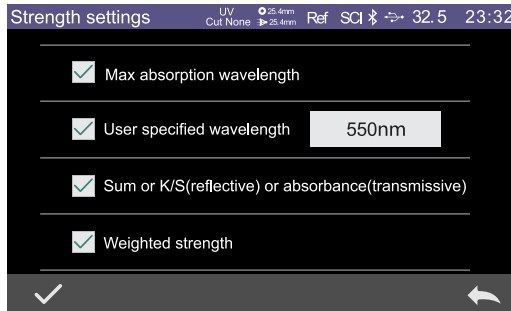

Figure 60 Strength settings interface

Click “Haze settings” you can choose the type of index displayed on interface of haze measurement , as shown in Figure 61.

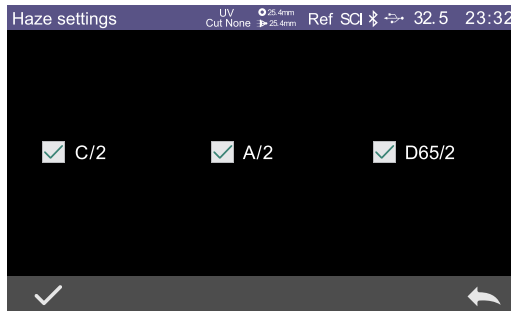



Figure 61 Haze setting interface

3.7 Display Setting

Click “Display Settings” on the main menu interface to enter the display setting interface, as shown in Figure 62. In this interface, the user can set some functions like open the Color offset or not, test result prompt, display mode, spectral curve,difference value, or rotate the screen 180° etc.

When select the function of the color offset, it will display the color deviation between the sample and the standard when the sample is measured. When it is closed, there is no corresponding prompt.

Benchtop Spectrophotometer

When select the test result prompt, if the test result exceeds the tolerance range set for the standard during the sample measurement, the red font "Fail" will be prompted. If it is within tolerance range, the green "Pass" is displayed. When select the spectrum curve, click  in the measurement interface, the spectrum curve will be displayed. If you also select the difference curve, the difference between the sample and the standard spectrum will be displayed .

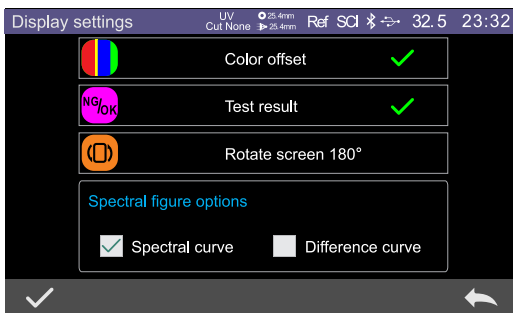

Figure 62 Display Setting Interface

3.8 System Setting

Click "System Settings" in the main menu to enter the system setting interface, as shown in Figure 63, Figure 64 and Figure 65.

System settings include: Auto Save, Bluetooth, Buzzer, Print Data, Control Mode, Language Setting, Time Date Setting, Backlight Time, System Tolerance, Screen Brightness, TEMP threshold, Calibration Validity, system error, Restore factory settings, About Instrument.

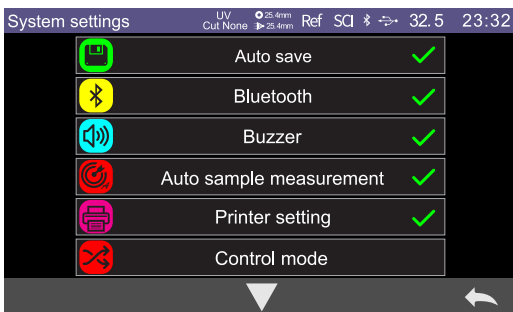

Figure 63 System Settings Interface 1

Benchtop Spectrophotometer

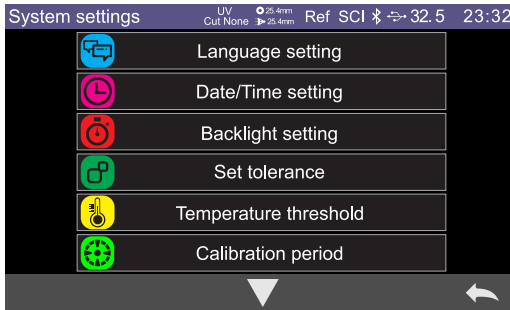



Figure 64 System Settings Interface 2



Figure 65 System Settings Interface 3

3.8.1 Auto Save

When Auto Save is turned on, all test results for every standard measurement will be automatically saved in the instrument otherwise the record will not be saved automatically and it is required to click the save icon  to save manually as shown in Figure 66:

Benchtop Spectrophotometer

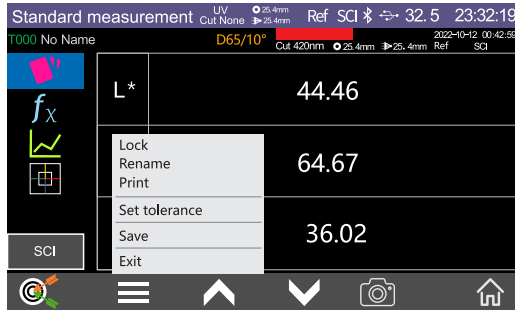

Figure 66 Data Saved Manually

3.8.2 Bluetooth

When the Bluetooth function is turned on, the instrument will automatically turn on the Bluetooth module and open the Bluetooth function of the PC color management software. The two will be paired. If the pairing is successful, the instrument would communicate with the PC color management software.

3.8.3 Buzzer Switch

The buzzer switch controls whether a beep sounds when measuring. When the buzzer is on, a beep will sound every time when the measurement starts; or there is no buzzer prompt during the test.

3.8.4 Automatic switching to sample measurement

Turned on the automatic switch to sample measurement, it will be automatically switched to the sample measurement after the measurement of standard.

3.8.5 Print Data

Open the print data switch and connect the printer to print data output. For more information, please refer to section 2.8

3.8.6 Control Mode

When the instrument communicates with the PC software, the user can set a specific control method as needed. In the system setting interface, click "Control Mode" to open the control mode interface. There are three options:

Benchtop Spectrophotometer

“Control Mode” to open the control mode interface. There are three options: Key, PC software, Key and PC Software. Select the corresponding method, and then confirm, as shown in Figure 67:

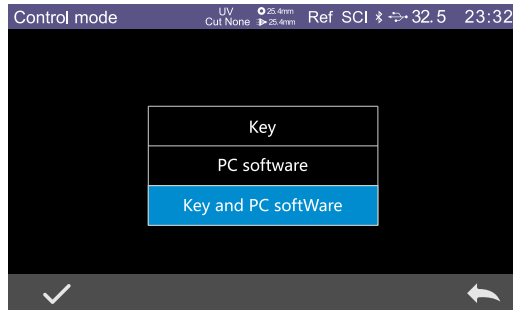

Figure 67 Control Mode Interface

Key: Select this mode. When the instrument communicates with the PC software, the instrument is only triggered by the instrument test key. The user needs to complete the data test through the instrument test key and upload the data to the PC software.

PC Software: Select this mode. When the instrument communicates with the PC Software, the instrument measurement can only be controlled by the PC color management software to complete the data test and upload the data to the PC software.

Key and PC Software: Select this mode. The user can complete the sample test through the instrument test key or PC software command, and upload the data. This is the instrument default mode.

3.8.7 Language Setting

Click "Language Settings" to select the appropriate language.

3.8.8 Time Date Setting

When the instrument is out of the factory, it is the local time of the manufacturer, and the user can set the time according to their requirement. In the system setting interface 2, click "Time Date Setting" to set the date and time as shown in Figure 68. click to save.

Benchtop Spectrophotometer

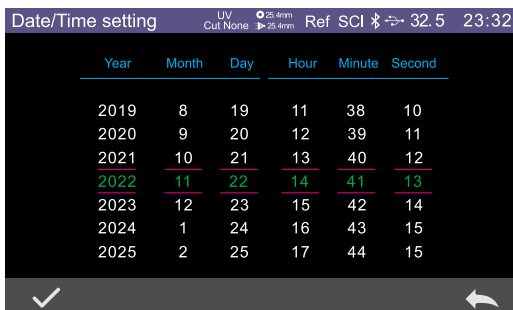

Figure 68 Time Date Setting Interface

3.8.9 Backlight Time

Click “Backlight Time” on the system setting interface to enter the “Backlight Time” interface.

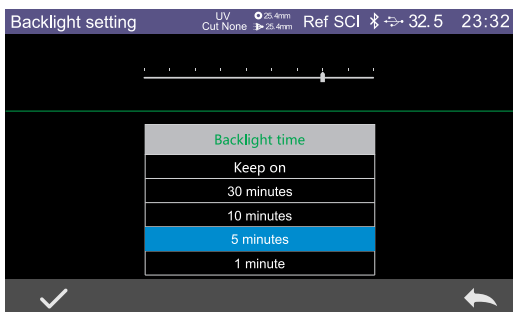



Figure 69 Backlight Setting Interface

The options of the backlight time are: Always on, 30 mins, 10 mins, 5 mins, 1 min. If you select Always On, the screen will always be lighted even instrument not in use for long time; if it is set to other modes, the instrument will start counting down from the last operation, and will enter the power saving state with screen lights out if there is no operation after the countdown ends.

When the instrument enters the power saving state, short press the test key to wake up the instrument.

Benchtop Spectrophotometer

Drag the scroll bar to to increase or decrease the screen brightness. after the adjustment, click  save settings, click  to cancel the save.

3.8.10 System Tolerance

Click “System Tolerance” on the system setting interface to enter the default system tolerance interface. Please check the section 2.5.1 for system tolerance settings

3.8.11 Temperature Threshold

Click “TEMP threshold” on the system setting interface to enter this interface. Set the temperature value upper and lower limits. When the temperature is abnormal and it changes greatly even exceeds the threshold (normally, the threshold is set to 3 degrees Celsius), the instrument will prompt that the black and white plate calibration is required to be done again as shown in Figure 70.

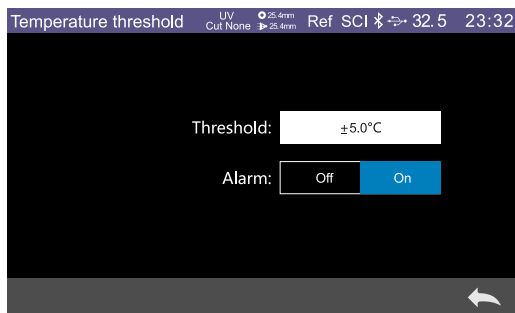

Figure 70 Temperature Threshold

3.8.12 Calibration Valid

Click "Calibration Valid" in the system settings interface to enter the "Calibration Valid" interface. set the effective time of calibration. After the effective time, the instrument will prompt you to correct again. The optional effective time of calibration is 4 hours, 8 hours, 24 hours, 7 days, startup calibration.

Black Calibration: When black calibration is turned on, then the black calibration must be required when black and white calibration is performed. Otherwise the black calibration is automatically skipped and the result of the

Benchtop Spectrophotometer

last calibration is still be used.

The reference light scattered can be set to "measured" or "0". When it is set to "measured", it is necessary to measure the reference light scattered during haze measurement and calibration. If set to 0, the calibration skips the reference light scattered and uses 0 as the reference.

The reference incident light can be set as "measured" or "100%". When it is set as measured, it is necessary to measure the reference incident light during haze measurement and calibration. If set to 100%, the calibration skips the reference incident light measurement and uses 100% as the reference.

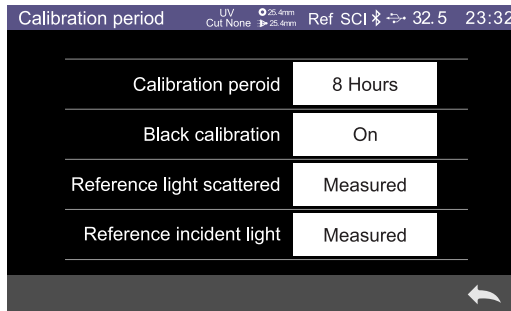

Figure 71 Calibration settings interface

3.8.13 System Error

Click "System Error" on the system setting interface to enter this interface. View the list of system hardware errors, as shown in Figure 72.

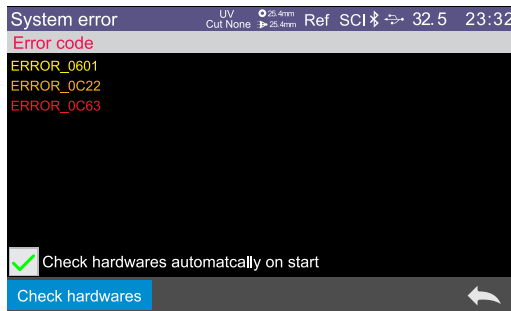

Figure 72 System Error Interface

Benchtop Spectrophotometer



When "Check hardware automatically on start" is checked, the fault detection will be automatically performed after power on. Otherwise, the fault detection is not performed during startup. In addition, you can also click the "Check hardware" for fault detection. When fault detection is carried out, the transmission bin should be emptied, and the measuring port should be closed without sample placed, otherwise the fault detection may be inaccurate.

Yellow error code indicates a warning. This fault does not affect the measurement, but some functions may not work properly.

Orange error code indicates the fault type that may cause inaccurate measurement or affect measurement stability.

Red error code indicates that the instrument has been unable to measure normally and needs to contact after-sales service.

3.8.14 Restore Factory Settings

Click "Restore Factory Settings" on the system setting interface to enter this interface, as shown in Figure 73. Click  to clear all measurement records and parameter settings and restore to the factory state; click  to cancel this operation.

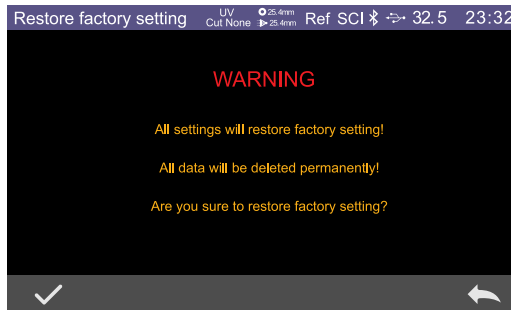

Figure 73 Restore Factory Settings Interface

3.8.15 About Instrument

Click "About Instrument" on the system setting interface to enter this interface.

Benchtop Spectrophotometer

View the product model, Instrumental SN, software version, hardware version, black plate number, white plate number and other information as shown in Figure 74:

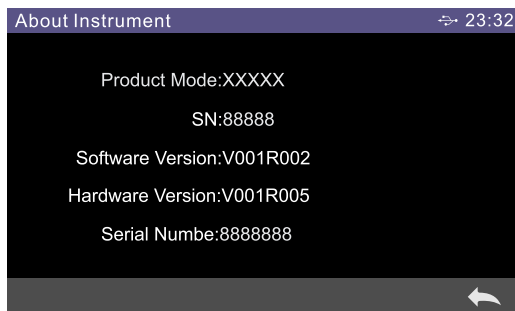

Figure 74 About Instrument Interface

4. DAILY MAINTENANCE

1) This instrument is a precision optical instrument. Please keep and use the instrument properly. Avoid using and storing the instrument under humid, strong electromagnetic interference, strong light and dust. It is recommended to use and store the instrument in a standard laboratory environment.

2) The white plate is a precision optical component. It should be kept and used properly. Avoid rubbing the work surface with sharp objects, avoid soiling the work surface with dirt, and avoid exposing the white plate under strong light. Regularly clean the white plate working surface with a cloth and alcohol. Before calibration, clean the dust on the white plate surface in time.

3) In order to ensure the validity of the test data, it is recommended to inspect the instrument and the white plate to the manufacturer or a qualified metrology institute for every year from the date of purchase.

4) This instrument get power from the external supply power charger. The power supply should be used in a standard manner to avoid frequent plugging and unplugging, to protect the power supply performance and to extend the service life.

5) Please do not disassemble the instrument privately. Please contact the relevant after-sales staff if there is any problem. Torn the easy-to-tear label will affect the after-sales maintenance service of the instrument.

5. TECHNICAL PARAMETERS

5.1 PRODUCT FEATURE

- 1、 High hardware configuration: 7-inch TFT pure color capacitive touch screen; Bluetooth 4.0; concave grating.
- 2、 Dual array 256-pixel CMOS detector; high lifetime stable LED / UV LED / xenon lamp.
- 3、 Measuring reflective and transmissive spectrum of sample, accurate Lab data, can be used for color matching and accurate color transfer.xel CMOS detector; high lifetime stable LED / UV LED / xenon lamp.
- 4、 Automatic identification of caliber, Φ 25.4/15/8/4mm four calibers can be switched at will, taking into account the special needs of customers.
- 5、 Temperature monitoring and compensation, built-in temperature sensor, monitor and compensate the test environment to ensure more accurate measurement results.
- 6、 Test wavelength range of 360~780nm, while built-in 400nm / 420nm / 460nm (limited to xenon version), test UV more professional.
- 7、 Independent light source detector, monitoring the light source changes at all times to ensure reliable light source.
- 8、 Multiple measure modes: quality mode, sample mode, to meet more customer needs.
- 9、 A variety of accessories: holding tool of reflective sample, transmission holder, for more conditions.
- 10、 Large-capacity storage space, which can store about 40,000 test data.
- 11、 Built-in Camera locating.
- 12、 PC color management software has powerful extensions.

Benchtop Spectrophotometer

5.2 TECHNICAL SPECIFICATIONS

| | |
|--------------------------------|---|
| Optical Geometry | Reflectance: D/8(Diffused illumination, 8-degree viewing angle); SCI/SCE, include UV/Exclude UV; Transmittance: D/0(Diffused illumination, 0-degree viewing angle) Haze (ASTM D1003); SCI/SCE, include UV/Exclude UV; Conforms to CIE No.15, GB/T 3978, GB 2893, GB/T 18833, ISO7724/1, ASTM E1164, DIN5033 Teil7 |
| Characteristic | Used for precise color analysis and transmission in the laboratory; Color transfer and quality control of reflective and transparent samples in industries such as plastic electronics, paint and ink, textile and clothing printing and dyeing, and printing. |
| Integrating Sphere Size | Φ154mm |
| Light Source Device | 360~780nm combined LED light source, 400nm cut-off light source, 420nm cut-off light source, 460nm cut-off light source (some models are equipped with different) |
| Spectral mode | Concave grating |
| Sensor | 256 Image Element Double Array CMOS Image Sensor |
| Wavelength Range | 360~780nm |
| Wavelength Interval | 10nm |
| Half Bandwidth | 5nm |
| Reflectance Range | 0~200% |
| Measuring Aperture | Reflective: Φ30mm/Φ25.4mm, Φ18mm/Φ15mm; Φ10mm/Φ8mm, Φ6mm/Φ4mm; Transmissive: Φ25.4mm |

Benchtop Spectrophotometer

| | |
|---------------------------------|---|
| | <p>Remarks: (Some models are equipped with differences)</p> <ol style="list-style-type: none"> 1. Automatic identification when switching aperture 2. Customers can configure the caliber and lens position according to their needs. |
| Specular Component | Reflectance: SCI/SCE, Transmittance: SCI/SCE |
| Color Space | CIE LAB, XYZ, Yxy, LCh, CIE LUV, Musell, s-RGB, HunterLab, β_{xy} , DIN Lab99 |
| Color Difference Formula | $\Delta E^*ab, \Delta E^*uv, \Delta E^*94, \Delta E^*cmc(2:1), \Delta E^*cmc(1:1), \Delta E^*00, DIN\Delta E99, \Delta E(Hunter)$ |
| Colorimetric Index | WI (ASTM E313, CIE/ISO, AATCC, Hunter), YI (ASTM D1925, ASTM 313), TI (ASTM E313, CIE/ISO), MI (Metamerism Index), Staining Fastness, Color Fastness, Color Strength, Opacity, Gardner Index, Pt-Co Index, 555 Index, China Pharmacopoeia, USA Pharmacopoeia, EU Pharmacopoeia, E_Beer_ColorI, CUMSA Color, Total transmittance |
| Observer Angel | 2°/10° |
| Illuminants | D65, A, C, D50, D55, D75, F1, F2, F3, F4, F5, F6, F7, F8, F9, F10, F11, F12, CWF, DLF, TL83, TL84, TPL5, U30 |
| Displayed Data | Spectrogram/data, sample chromaticity value, color difference/graph, chromaticity diagram, color simulation, pass/fail result, color offset |
| Measurement Time | About 2.4 seconds (testing SCI/SCE simultaneously takes about 5 seconds) |
| Repeatability | <p>Spectral reflectance: $\Phi 25.4\text{mm}/\text{SCI}$, Standard deviation within 0.04% Chromaticity value: $\Phi 25.4\text{mm}/\text{SCI}$, ΔE^*ab within 0.01 (after preheating and calibration of the instrument, measure the average value of the whiteboard 30 times at intervals of 5 seconds)</p> <p>Spectral transmittance: $\Phi 25.4\text{mm}/\text{SCI}$, Standard deviation within 0.05% Chromaticity value: $\Phi 25.4\text{mm}/\text{SCI}$, ΔE^*ab within 0.02 (after preheating and calibration of the instrument, measure the average value of the whiteboard 30 times at intervals of 5 seconds)</p> |

Benchtop Spectrophotometer

| | |
|-------------------------------|---|
| Inter-instrument Error | Inter-instrument Error $\Phi 25.4\text{mm}/\text{SCI}$, ΔE^*ab within 0.12 (Average for 12 BCRA Series II color tiles) (some models' configuration is different) |
| Size | Length*width*Height=370X300X200mm |
| Weight | About 9.6kg |
| Power Supply | DC 24V,3A Power Adapter |
| Illuminant Life Span | More than 3 million measurements in 5 years / more than 200,000 measurements in 3 years (some models' configuration is a little different) |
| Display | 7 inches TFT color capacitive screen-touch display |
| Date Port | USB,Bluetooth (select models), print serial port |
| Data Storage Capacity | Standard:5000 Pcs; Sample:4000 Pcs. (one PCS can include both SCI and SCE. |
| Language | Simplified Chinese, Traditional Chinese, English (German, French, Spanish can be customized) |
| Working Environment | 0~40°C(32~104°F) |
| Storage Environment | -20~5°C(-4~122°F) |
| Standard Accessory | Power adapter, manual, quality management software (official website download), data cable, standard calibration board, black calibration box, transmission black baffle, sample holder, 25.4 caliber, 15 caliber, 8 caliber, 4 caliber (some models have different diameters), transmission testing fixture assembly (some models have them), micro hole (4mm) transmission testing fixture assembly (some models have them) |
| Optional Accessory | Micro printers, inverted testing fixtures for instruments, culture dishes |
| Note: | The technical parameters are for reference only, the specific values are subject to the actual product of sales. |



2.004.01.0159